

## **WARNING**

*Death, serious injury, or fire hazard could result from improper connection of this instrument. Read and understand this manual before connecting this instrument. Follow all installation and operating instructions while using this instrument.*

*Connection of this instrument must be performed in compliance with the National Electrical Code (ANSI/NFPA 70-1996) of USA and any additional safety requirements applicable to your installation.*

*Installation, operation, and maintenance of this instrument must be performed by qualified personnel only. The National Electrical Code defines a qualified person as one familiar with the construction and operation of the equipment and the hazards involved.*

Power Platform<sup>®</sup> PP1 & PP1E

TASKCard<sup>®</sup> - INRUSH

OPERATOR'S MANUAL

Revision A

April 15, 1997



DRANETZ-BMI  
1000 New Durham Road  
Edison, New Jersey 08818-4019

Part Number OM-PP1-TASK-INRUSH

## **ADVERTENCIA**

Una conexión incorrecta de este instrumento puede producir la muerte, lesiones graves y riesgo de incendio. Lea y entienda este manual antes de conectar. Observe todas las instrucciones de instalación y operación durante el uso de este instrumento.

La conexión de este instrumento debe ser hecha de acuerdo con las normas del Código Eléctrico Nacional (ANSI/NFPA 70-1996) de EE. UU., además de cualquier otra norma de seguridad correspondiente a su establecimiento.

La instalación, operación y mantenimiento de este instrumento debe ser realizada por personal calificado solamente. El Código Eléctrico Nacional define a una persona calificada como "una que esté familiarizada con la construcción y operación del equipo y con los riesgos involucrados."

## **AVERTISSEMENT**

Si l'instrument est mal connecté, la mort, des blessures graves, ou un danger d'incendie peuvent s'en suivre. Lisez attentivement ce manuel avant de connecter l'instrument. Lorsque vous utilisez l'instrument, suivez toutes les instructions d'installation et de service.

Cet instrument doit être connecté conformément au National Electrical Code (ANSI/NFPA 70-1996) des Etats-Unis et à toutes les exigences de sécurité applicables à votre installation.

Cet instrument doit être installé, utilisé et entretenu uniquement par un personnel qualifié. Selon le National Electrical Code, une personne est qualifiée si "elle connaît bien la construction et l'utilisation de l'équipement, ainsi que les dangers que cela implique".

## **WARNUNG**

Der falsche Anschluß dieses Gerätes kann Tod, schwere Verletzungen oder Feuer verursachen. Bevor Sie dieses Instrument anschließen, müssen Sie die Anleitung lesen und verstanden haben. Bei der Verwendung dieses Instruments müssen alle Installation- und Betriebsanweisungen beachtet werden.

Der Anschluß dieses Instruments muß in Übereinstimmung mit den nationalen Bestimmungen für Elektrizität (ANSI/NFPA 70-1996) der Vereinigten Staaten, sowie allen weiteren, in Ihrem Fall anwendbaren Sicherheitsbestimmungen, vorgenommen werden.

Installation, Betrieb und Wartung dieses Instruments dürfen nur von Fachpersonal durchgeführt werden. In dem nationalen Bestimmungen für Elektrizität wird ein Fachmann als eine Person bezeichnet, welche "mit der Bauweise und dem Betrieb des Gerätes sowie den dazugehörigen Gefahren vertraut ist."

# Safety Summary

---

**Definitions**      WARNING statements inform the user that certain conditions or practices could result in loss of life or physical harm.

CAUTION statements identify conditions or practices that could harm the Power Platform, its data, other equipment, or property.

NOTE statements call attention to specific information.

---

**Symbols**      The following International Electrotechnical Commission (IEC) symbols are marked on the top and rear panel in the immediate vicinity of the referenced terminal or device:



Caution, refer to accompanying documents (this manual).



Alternating current (ac) operation of the terminal or device.



Direct current (DC) operation of the terminal or device.



Symbol preceding a fuse rating indicates the fuse is a time delay (slow-blow) type. Example: T10A = time-delay, 10 Ampere fuse.

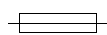

Fuse WARNING notice.



Protective conductor terminal.



Power Switch.

---

**Definiciones**      Las ADVERTENCIAS informan al usuario de ciertas condiciones o prácticas que podrían producir lesiones mortales o daño físico.

Las PRECAUCIONES identifican condiciones o prácticas que podrían dañar la Power Platform, sus datos, otros equipos o propiedad.

Las NOTAS llaman la atención hacia la información específica.

---

*Continued on next page*

## Safety Summary, Continued

---

### Símbolos

Los siguientes símbolos de la Comisión Internacional Electrotécnica (IEC) aparecen marcados en el panel superior y el posterior inmediatos al terminal o dispositivo en referencia:



Precaución, consulte los documentos adjuntos (este manual).



Operación de corriente alterna (ca) del terminal o dispositivo.



Operación de corriente continua (CC) del terminal o dispositivo.

T

El símbolo que precede la capacidad nominal de un fusible indica que se trata de un fusible con retardo de tiempo (fundido lento).  
Ejemplo: T10A = fusible con retardo de tiempo, 10 Amperios.

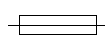

ADVERTENCIA de fusible.



Terminal de protección del conductor.



Interruptor de encendido.

---

### Définitions

Les messages d'AVERTISSEMENT préviennent l'utilisateur que certaines conditions ou pratiques pourraient entraîner la mort ou des lésions corporelles.

Les messages de MISE EN GARDE signalent des conditions ou pratiques susceptibles d'endommager "Power Platform", ses données, d'autres équipements ou biens matériels.

Les messages NOTA attirent l'attention sur certains renseignements spécifiques.

---

*Continued on next page*

## Safety Summary, Continued

### Symboles

Les symboles suivants de la Commission électrotechnique internationale (CEI) figurent sur le panneau arrière supérieur situé à proximité du terminal ou de l'unité cité:



Mise en garde, consultez les documents d'accompagnement (ce manual).



Fonctionnement du terminal ou du dispositif sur le courant alternatif (c.a.).



Fonctionnement du terminal ou de l'unité en courant continu (CC).

T

Symbole précédant la valeur nominale d'un fusible et indiquant que le fusible est du type à temporisation (fusible à action retardée).  
Exemple : T10A = fusible de 10 ampères à temporisation.

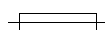

AVERTISSEMENT sur les fusibles.



Borne conductrice de protection.



Interrupteur de tension.

### Definitionen

WARNUNGEN informieren den Benutzer darüber, daß bestimmte Bedingungen oder Vorgehensweisen körperliche oder tödliche Verletzungen zur Folge haben können.

VORSICHTSHINWEISE kennzeichnen Bedingungen oder Vorgehensweisen, die zu einer Beschädigung von Power Platform, seiner Daten oder anderer Geräte bzw. von Eigentum führen können.

HINWEISE machen auf bestimmte Informationen aufmerksam.

*Continued on next page*

## Safety Summary, Continued

---

### Symbole

Die folgenden Symbole der Internationalen Elektrotechnischen Kommission (International Electrotechnical Commission; IEC) befinden sich auf der Abdeck- und Seitenplatte unmittelbar am betreffenden Terminal oder Gerät.



Vorsichtshinweis, siehe Begleitdokumente (dieses Handbuch).



Wechselstrombetrieb des Terminals bzw. Geräts.



Gleichstrombetrieb im Terminal oder Gerät.

T

Dieses Symbol vor einem Sicherungswert weist darauf hin, daß es sich um eine Sicherung mit Zeitverzögerung (Trägsicherung) handelt. Beispiel: T10A = Trägsicherung mit 10 Ampere.

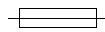

WARNHINWEIS Sicherung.



Terminal-Schutzleiter.



Netzschalter.

## Safety Summary, Continued

---

### Safety precautions

The following safety precautions must be followed whenever any type of connection is being made to the instrument.

- Connect the green safety (earth) ground first, before making any other connections.
- When connecting to electric circuits or pulse initiating equipment, open their related breakers. DO NOT install any connection of the instrument on live power lines.
- Connections must be made to the instrument first, then connect to the circuit to be monitored.
- Wear safety glasses and insulated gloves when making connections to power circuits.
- Hands, shoes and floor must be dry when making any connection to a power line.
- Make sure the unit is turned OFF before connecting probes to the rear panel.
- Before each use, inspect all cables for breaks or cracks in the insulation. Replace immediately if defective.

---

### Medidas de seguridad

Las medidas de seguridad siguientes deberán observarse cuando se realice cualquier tipo de conexión al instrumento.

- Antes de hacer cualquier conexión, deberá enchufarse el conector de seguridad verde a tierra.
- Cuando se haga conexiones a circuitos eléctricos o a equipo de activación por pulso, deberá abrirse sus respectivas cajas de seguridad. NO deberá hacerse ninguna conexión del instrumento en líneas eléctricas bajo tensión.
- Las conexiones deberán hacerse primero al instrumento y, luego, al circuito a ser monitorizado.
- Al hacer conexiones a circuitos eléctricos, deberá utilizar anteojos y guantes protectores.
- Sus manos, zapatos y el piso deberán estar secos en todo momento en que se haga una conexión a un cable eléctrico.
- Verifique que la unidad esté DESACTIVADA antes de conectar sondas en el panel posterior.
- Previo a cada uso, deberá verificarse que los cables no estén rotos y que el material aislante no tenga rajaduras. Reemplace de inmediato cualquier parte defectuosa.

---

### Mesures de Sécurité

Les mesures de sécurité suivantes doivent être prises chaque fois qu'un type de connexion quelconque est effectué sur l'instrument.

---

*Continued on next page*

## Safety Summary, Continued

---

- Connecter d'abord la prise de terre de sécurité verte (terre) avant d'effectuer toute autre connexion.
  - Ouvrir les disjoncteurs correspondants lors d'une connexion à des circuits électriques ou à des équipement de génération d'impulsions. NE PAS effectuer de connexion d'instrument sur des lignes électriques sous tension.
  - Une fois toutes les connexions de l'instrument effectuées, connecter au circuit à contrôler.
  - Porter des lunettes de protection et des gants isolants pour effectuer des connexions aux circuits électriques.
  - S'assurer que les mains, les chaussures et le sol soient secs lors de connexions à une ligne électrique.
  - S'assurer que l'unité est ÉTEINTE avant de connecter les sondes au panneau arrière.
  - Inspecter tous les câbles, avant chaque utilisation, pour s'assurer que les isolants ne sont pas coupés ou fendus. Remplacer immédiatement tous les équipements défectueux.
- 

### Sicherheitsvorkehrungen

- Die folgenden Sicherheitsvorkehrungen sind immer dann zu befolgen, wenn eine Verbindung zum Instrument hergestellt wird.
- Schließen Sie zuerst die grüne Sicherheits-/Erdleitung an, bevor Sie eine andere Verbindung herstellen.
  - Öffnen Sie beim Anschluß an elektrische Stromkreise oder Impulsauslösungseinrichtungen die entsprechenden Unterbrecher. Es dürfen KEINE Anschlüsse an das Instrument unter stromführenden Spannungsleitungen montiert werden.
  - Die Verbindungen müssen zuerst am Instrument und danach an der zu überwachenden Schaltung hergestellt werden.
  - Tragen Sie Schutzbrillen und Isolierhandschuhe, wenn Sie Anschlüsse an den Stromkreisen vornehmen.
  - Hände, Schuhe und Fußboden müssen trocken sein, wenn Sie Anschlüsse an den Stromkreisen durchführen.
  - Stellen Sie sicher, daß das Gerät AUSgeschaltet ist, bevor Sie an der rückwärtigen Konsole Meßfühler anschließen.
  - Prüfen Sie vor jedem Gebrauch alle Kabel auf Bruchstellen und Risse in der Isolierung. Wechseln Sie schadhafte Kabel sofort aus.
-



## Change Status

---

### Revisions

Original Issue: March 1, 1994.  
Change 1: April 15, 1994, ECOs 3294 and 3299.  
Change 2: April 1, 1995, ECO 3378 and ECR 3380-1.  
Change 3: November 25, 1996, ECO 3387.  
Revision A: April, 1997, ECO 3313 and 3437.

---

### Revised Sections

Section	Change No.	Section	Change No.
Cover	A	Appendix B	A
Table of Contents	A	Appendix C	A
Chapter 1	A	Appendix D	A
Chapter 2	A	Appendix E	A
Chapter 3	A	Appendix F	A
Chapter 4	A	Appendix G	2
Chapter 5	A	Appendix H	O
Chapter 6	A	Appendix I	A
Chapter 7	A	Appendix J	O
Chapter 8	A	Glossary	A
Chapter 9	A	Index	A
Appendix A	A		

---

## Statements and Notices

---

**Statement of warranty**

All products of Dranetz-BMI are warranted to the original purchaser against defective material and workmanship for a period of one year from the date of delivery. Dranetz-BMI will repair or replace, at its option, all defective equipment that is returned, freight prepaid, during the warranty period. There will be no charge for repair provided there is no evidence that the equipment has been mishandled or abused. This warranty shall not apply to any defects resulting from improper or inadequate maintenance, buyer-supplied hardware/software interfacing, unauthorized modification or misuse of the equipment, operation outside of environmental specifications, or improper site preparation or maintenance.

---

**Statement of reliability**

The information in this manual has been reviewed and is believed to be entirely reliable, however, no responsibility is assumed for any inaccuracies. All material is for informational purposes only and is subject to change without prior notice.

---

**Notice regarding FCC compliance**

This device has been tested and found to comply with the limits for a Class A digital device, pursuant to Part 15 of the FCC Rules. These limits are designed to provide reasonable protection against harmful interference when the equipment is operated in a commercial environment. This equipment generates, uses, and can radiate radio frequency energy and, if not installed and used in accordance with the instruction manual, may cause harmful interference to radio communications. Operation of this equipment in a residential area is likely to cause harmful interference in which case the user will be required to correct the interference at his/her own expense.

---

**Notice regarding proprietary rights**

This publication contains information proprietary to Dranetz-BMI. By accepting and using this manual, you agree that the information contained herein will be used solely for the purpose of operating equipment of Dranetz-BMI.

---

*Continued on next page*

## Statements and Notices, Continued

---

### Copyright

This publication is protected under the Copyright laws of the United States, Title 17 et seq. No part of this publication may be reproduced, transmitted, transcribed, stored in a retrieval system, or translated into any language or computer language, in any form, by any means, electronic, mechanical, magnetic, optical, chemical, manual, or otherwise, without the prior written consent of Dranetz-BMI, 1000 New Durham Road, Edison, New Jersey 08818.

Copyright © 1997, Dranetz-BMI  
All Rights Reserved. Printed in the United States of America.

---

### Trademarks

Power Platform, TASKCard, and Scope Mode are registered trademarks of Dranetz-BMI.

---



# Table of Contents

---

Safety Summary .....	iii
Change Status .....	ix
Statements and Notices .....	x
CHAPTER 1 - Introduction	
Overview .....	1-1
Unpacking The Power Platform .....	1-3
Physical Description .....	1-4
Operational Description .....	1-6
CHAPTER 2 - Controls, Indicators, and Connectors	
Overview .....	2-1
Front Panel .....	2-2
Rear Panel .....	2-4
Positioning the Unit .....	2-8
CHAPTER 3 - Getting Started	
Overview .....	3-1
Section A - Turn On Procedures	
Overview .....	3-2
Setting the Voltage Selector .....	3-3
Power Requirements .....	3-5
Installing a TASKCard .....	3-6
Turning the Unit On .....	3-7
Section B - Voltage and Current Cable Connections	
Overview .....	3-11
Connecting a Voltage Probe .....	3-15
Connecting to a Potential Transformer (PT) .....	3-19
Connecting a Current Probe .....	3-21
Connecting to a Current Transformer (CT) .....	3-26
Connecting to an Isolated Current Transformer (ISO) .....	3-28
Section C - Connection Diagrams	
Overview .....	3-34
Single Phase .....	3-36
Split Phase .....	3-37
Four Wire Wye .....	3-38
Floating Delta .....	3-39
Delta, One Leg Grounded .....	3-40
Open Leg Delta .....	3-41
High-Leg Delta .....	3-42
Phasor Diagrams for Standard Power Connections .....	3-43

## Table of Contents, Continued

---

Section D - Scope and Meter Mode	
Overview.....	3-46
Viewing Scope Mode.....	3-47
Viewing Meter Mode.....	3-49
Viewing Voltage and Current Phasors.....	3-52
Viewing Voltage and Current Harmonics .....	3-53
 CHAPTER 4 - Housekeeping Functions	
Overview.....	4-1
Entering or Editing a Site Name .....	4-2
Setting the Time and Date .....	4-4
Selecting the Language.....	4-6
Setting the Audible Alarm and LCD Mode .....	4-7
Running a Self-Test .....	4-8
 CHAPTER 5 - Input Channels Setup	
Overview.....	5-1
Turning Input Channels On and Off .....	5-2
Selecting Your Circuit Type .....	5-4
About Scale Factors .....	5-6
Entering Scale Factors .....	5-7
About Frequency Synchronization .....	5-9
Selecting Sync Frequency.....	5-11
 CHAPTER 6 - Inrush Trigger Setup	
Overview.....	6-1
Set Inrush Trigger Type Screen .....	6-3
Setting Trigger Parameters .....	6-6
Manual Trigger .....	6-8
RMS Trigger .....	6-9
External Trigger.....	6-12
Data Collection and Processing .....	6-16

## Table of Contents, Continued

---

### CHAPTER 7 - Viewing Data

Overview.....	7-1
Envelope Plot.....	7-2
Scope Mode.....	7-4
Zoom.....	7-5
Scroll.....	7-9
Data Channel Selection.....	7-10
Envelope Parameters.....	7-12
Data Menu.....	7-14

### CHAPTER 8 - Memory Card Functions

Overview.....	8-1
Write to Memory Card.....	8-2
Read Memory Card.....	8-5
Format Memory Card.....	8-6

### CHAPTER 9 - Printer Operation

Overview.....	9-1
Printer Controls.....	9-2
Normal Operation.....	9-5
Paper Replacement.....	9-7

### APPENDIX A - Optional Accessories

Optional Accessories List.....	A-2
Optional Accessories Descriptions.....	A-4

### APPENDIX B - Repacking for Return Shipment

### APPENDIX C - Battery Specifications and Replacement Procedure

Overview.....	C-1
Battery Specifications.....	C-2
Battery Pack Safety Precautions.....	C-3
Battery Pack Replacement.....	C-5
Memory Card Battery Replacement.....	C-6

### APPENDIX D - Fuse Replacement

Overview.....	D-1
Main Power Fuses.....	D-2
Battery Fuse.....	D-5

# Table of Contents, Continued

---

## APPENDIX E - Operator Replaceable Parts List

## APPENDIX F - Technical Specifications

Overview.....	F-1
General.....	F-2
Interfaces.....	F-3
Measured Parameters.....	F-5
Computed Parameters.....	F-7
Current Probes.....	F-9
Isolated Current Transformer Boxes.....	F-10

## APPENDIX G - PP1-Inrush Messages

Overview.....	G-1
Message Types.....	G-2
Messages.....	G-3

## APPENDIX H - Connecting an External DC Power Supply

Overview.....	H-1
Making and Connecting the DC Input Cable.....	H-3
External Battery Filter.....	H-6
Extension Cables.....	H-7
Installing the Battery Filter.....	H-8

## APPENDIX I - Inrush TASKCard Menu Structure

## APPENDIX J - Internal Modem Commands

Command Codes.....	J-2
Register Access Codes.....	J-5

## Glossary

## Index





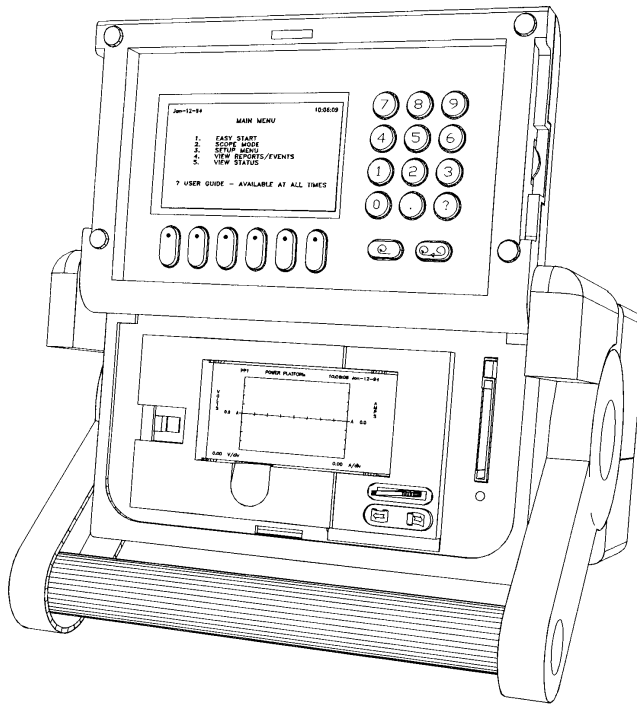

8600-37

Dranetz-BMI Power Platform, Models PP1 & PP1E.

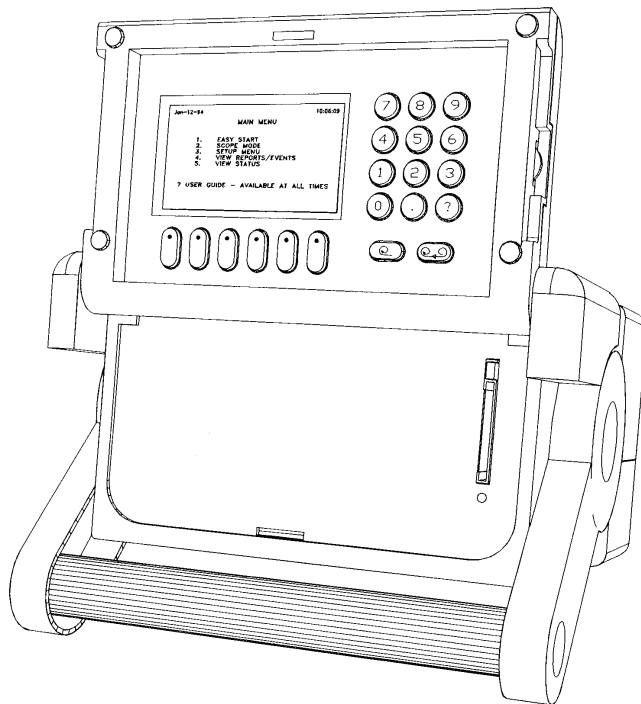

8600-46

Dranetz-BMI Power Platform, Models PP1 & PP1E, without printer.

# Chapter 1

## Introduction

### Overview

---

**Power Platform description** The Dranetz-BMI Power Platform, Models PP1 and PP1E, shown on the facing page, introduces a new concept in power monitoring equipment by allowing you to change the type of monitoring the unit does by changing a TASKCard.

---

**TASKCard definition** A TASKCard is a removable memory card that is installed in the rear panel of the Power Platform and contains an operating system that is designed for a specific application (task).

---

**Inrush TASKCard** The Inrush TASKCard, shown below, is a card-based operating system that enables the Power Platform to monitor applications where the start-up or transient conditions lasts for five or more cycles. Other applications include monitoring of systems where a longer pre- and post-fault recording time is the primary concern rather than sub-cycle data analysis.

One of the most common examples is the monitoring of the inrush current during the starting of an AC motor. Other examples include the energizing of transformers and power supplies, the de-energizing of power generating equipment, and distribution-level breaker reclosures.

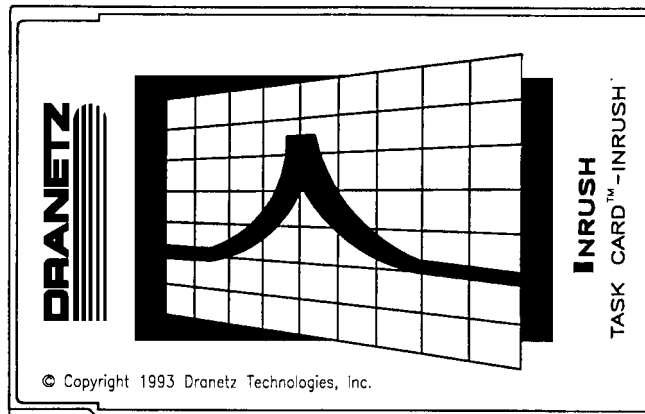

8600-50

---

*Continued on next page*

## Overview, Continued

---

**Available TASKCards**

Each available TASKCard provides the Power Platform with different capabilities. Refer to the optional accessories list in Appendix A for a description of all available TASKCards.

---

**This manual**

This manual contains instructions for operating the Dranetz-BMI Power Platform, PP1, with the Inrush TASKCard installed.

Throughout this manual reference to the Power Platform will be made when hardware or other generic functions are being described. Where software functions are being referenced, the term PP1-Inrush will be used.

This manual describes the inrush current measurements and their associated displays and reports. The specific period of time this inrush current is measured and recorded is selected by the operator.

Measurements are not limited to inrush current waveforms. Other data, for which a valid voltage trigger can be used, can be measured also. A similar type application is transient or fault recording.

Inrush measurements consist of proper cable connections, selection of the method of triggering data recording, length of test time, and number of recording channels.

---

**Index**

An Index is provided at the rear of this manual to assist you in quickly finding related subject information.

---

**In this chapter**

The following topics are covered in this chapter.

<b>Topic</b>	<b>See Page</b>
Unpacking The Power Platform	1-3
Physical Description	1-4
Operational Description	1-6

---

# Unpacking The Power Platform

---

## Introduction

For maximum protection against possible shipping damage, the Power Platform has been sealed in a two-piece, pre-molded urethane foam pack, enclosed within a durable shipping carton. After opening the carton, inspect the contents for possible shipping damage and check the carton inventory. Save the carton for possible return of the Power Platform.

---

## Unpacking

Unpack the Power Platform from the carton as follows:

Step	Action
1	Remove any remaining literature inside the top of the carton.
2	Carefully remove the Power Platform from its shipping carton.
3	Remove all accessories inside the carton. Check that the standard accessories (See next page) are included.
4	Place all of the shipping materials back into the carton, close its flaps, and store it away. DO NOT throw away the carton and packing materials. Save the carton and packing materials in case you have to return the Power Platform to Dranetz-BMI for maintenance, repair, or calibration.

---

## Shipping Damage Inspection

Visually inspect the Power Platform for possible shipping damage. If any damage exists, first notify and file an insurance claim with your carrier or underwriter or both. Then notify Dranetz-BMI Customer Service Department of your intentions to return the unit. DO NOT return the Power Platform without prior instructions from Dranetz-BMI Customer Service Department, telephone 732-287-3680 or 1-800-372-6832.

---

## Repacking for Return Shipment

If you have to return the Power Platform to Dranetz-BMI Customer Service Department, repack it in its original packing materials. Refer to the repacking instructions in Appendix B.

---

## Physical Description

---

**Dimensions** The Dranetz-BMI Power Platform is a self-contained, portable instrument weighing less than 21 pounds and measuring 10" deep by 13" wide by 7" high.

---

**Front panel** The front panel, including screen, keypad, printer, and memory card is protected by a locking, flip-top type display housing. The padded bail handle can be used as a carrying handle or as a means to position the unit. See Chapter 2 for description of the front panel controls and indicators and how to position the Power Platform.

---

**Rear panel** The rear panel contains the input and output connectors including the slot for the TASKCard. See Chapter 2 for the description of rear panel controls, indicators, and connectors.

---

**Standard accessories** The following table lists the Power Platform's standard accessories.

Part Number	Description
OM-PP1-TASK-INRUSH	Operator's Manual
115323-G1	Thermal Paper (4 rolls)
113218-G4*	Terminal Block, 8 pin
TASKCard-Inrush	Inrush TASKCard
115818-G1	TASKCard Cover
107539-G13	TASKCard cover screw, Phillips head 4-40 x 1/4" long. Two used.
115815-G1**	Measurement Cable Set (Domestic)
115815-G2**	Measurement Cable Set (Euro)
115815-G3**	Measurement Cable Set (UK)
115520-G1	Wire Marker Kit
113218-G3	Terminal Block, 6 pin
MIR-UTIL-ASCII	ASCII Conversion Utility Program Disk
115240-G1	Shipping Carton
107506	Connector Plug, battery
* Not used with this TASKCard.	
** User specified, one standard only.	

---

*Continued on next page*

## Physical Description, Continued

---

**Optional accessories**

The optional accessories are described in Appendix A.

---

**Batteries**

Refer to Appendix C for the description and replacement of the batteries contained in the Power Platform.

---

**Fuses**

Refer to Appendix D for fuse information.

---

**Replaceable parts**

Refer to Appendix E for operator replaceable parts.

---

# Operational Description

---

## Monitoring Configuration

The Dranetz-BMI PP1-Inrush can monitor devices in any of the following power configurations:

- Single phase, 2 wire
- Split phase, 3 wire
- 3 phase, 3 wire (delta)
- 3 phase, 4 wire (wye)

While monitoring any of the above configurations, the Power Platform can also be wired to monitor neutral to ground voltage and neutral current.

---

## Technical Specifications

Specifications for the PP1-Inrush, measured parameters, computed parameters, current probes, and isolated current transformers, are listed in Appendix F.

---

## Meter Mode

In addition to monitoring for current inrush, the PP1-Inrush is a true RMS voltmeter and true RMS clamp-on ammeter. Voltage and current measurements, along with all other calculated parameters, are displayed on the Meter Mode screens. The PP1-Inrush also functions as a phase angle meter, wattmeter, VAR meter, PF meter, frequency meter, and harmonics meter.

Available Parameters: The following table lists all the parameters and their abbreviations as displayed on the Power Platform's screens.

Parameter	Abbreviation
Volts	V
Amps	I
Watts	W
Volt-Amperes	VA
Volt-Amperes Reactive	VAR
Power Factor (True)	PF
Frequency	HZ

---

*Continued on next page*



## Operational Description, Continued

---

### Meter Mode (continued)

Parameter	Abbreviation
Voltage Unbalance	Vunb%
Voltage Harmonic Distortion	Vthd
Current Harmonic Distortion	Ithd
Current Crest Factor	Icf
K-Factor	Kf

Phase angle meter: The PP1-Inrush can display voltage and current phasors for all of the channels. Functioning as a phase angle meter, the Power Platform can display system unbalance conditions. The phase angle display can also verify that monitoring connections have been made correctly.

### Scope mode

When in scope mode, the PP1-Inrush is an oscilloscope, displaying real-time waveforms of voltage and current for all channels.

---

## Operational Description, Continued

- Digital Inputs** The Power Platform's rear panel has four digital inputs. These inputs can be used for
- External triggers, to start data collection, and
  - Start/stop measurements, for recording measurements only during a specified interval

**Memory Card** A memory card is used with the Power Platform to provide a removable, rugged, compact, solid state mass storage device. A memory card, shown below, uses low power, has an internal battery for data retention, and is available as an optional accessory in sizes from 512 Kbytes to 2 Mbytes.

For information about the battery, refer to Appendix C.

The PP1-Inrush treats the memory card like a floppy disk storing files in a DOS format. In the PP1-Inrush, the memory cards are used to store inrush data.

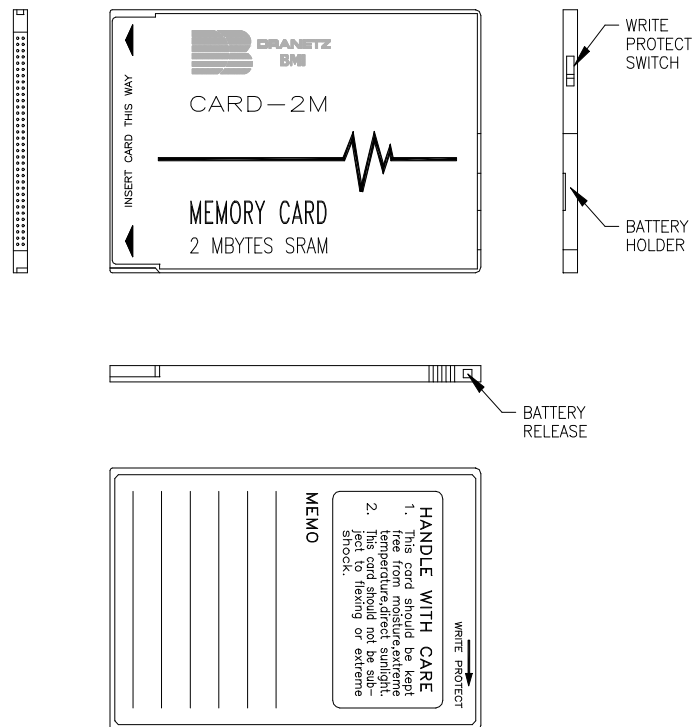

8000-18

*Continued on next page*

## Operational Description, Continued

---

<b>Calibration</b>	<p>The recommended calibration interval for this unit is once every 12 months.</p> <p>We recommend that you return the unit to the factory for calibration. If you decide to do so, first contact the Dranetz-BMI Customer Service Department to obtain a Return Material Authorization (RMA) number.</p> <p>Telephone: (732) 287-3680 FAX: (732) 248-9240</p>
<b>PP1-Inrush Messages</b>	<p>Messages that appear on the display are described in Appendix G.</p>
<b>Connecting to an external power source</b>	<p>Connecting the Power Platform to an external DC power source is described in Appendix H.</p>
<b>Menu structure</b>	<p>The PP1-Inrush menu structure is described and shown in Appendix I.</p>

---



# Chapter 2

## Controls, Indicators, and Connectors

### Overview

---

**Introduction** This chapter identifies and describes the controls, indicators, and connectors on the front and rear panels of the Power Platform. In addition, the methods of positioning the unit for carrying, operating, and securing the unit are discussed.

---

**In this chapter** The following topics are covered in this chapter.

Topic	See Page
Front Panel	2-2
Rear Panel	2-4
Positioning the Unit	2-8

---

# Front Panel

Diagram

Models PP1 & PP1E

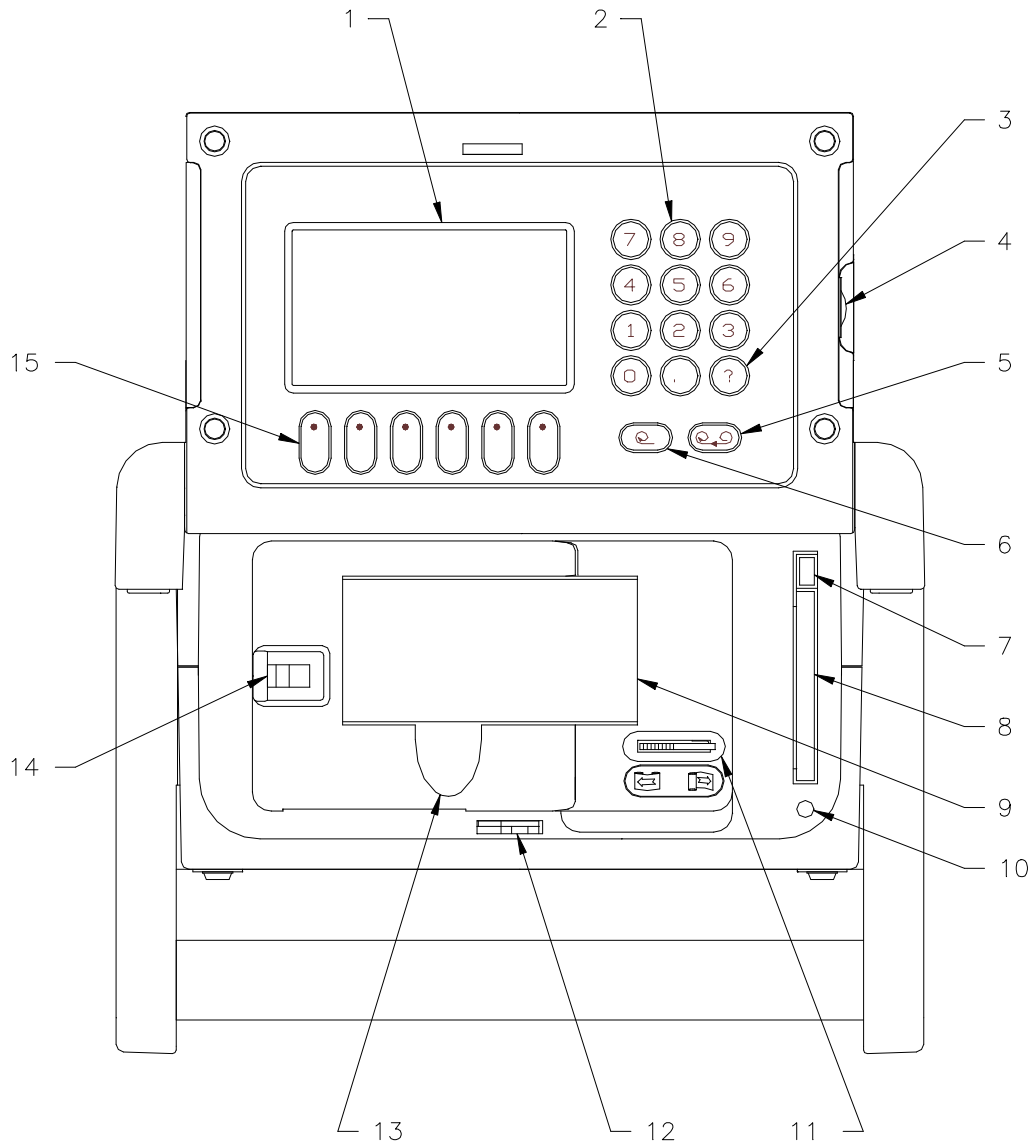

8600-16

*Continued on next page*

## Front Panel, Continued

Parts Table

Part	Function
1	Liquid Crystal Display (LCD). Provides 2 3/4 x 4 1/2 inch (5 x 10 cm) display consisting of 240 by 128 pixels (dots) of text and graphic information. Has electroluminescent (EL) backlighting for low light level viewing.
2	Numeric keypad. Consists of keyboard keys 0 thru 9 and decimal point (.). Permits menu selection and numerical data entry.
3	Question Mark Key. Provides selection of User Guide to display help screens with reference to screen displayed at any time.
4	Contrast Control. Provides contrast range control for LCD viewing.
5	Paper Feed. Controls paper feed and take up to advance the paper uniformly across window from right to left.
6	Paper Take-up. Controls paper slack.
7	Memory Card Release. Ejects memory card.
8	Memory Card Holder. Holds and connects memory card to internal circuitry.
9*	Thermal Paper Printout. High-resolution thermal print of real-time data and report information.
10	Memory Card Busy LED. Yellow LED indicates memory card is being accessed.
11*	Run/Load Printhead Control. Lever in left position for normal run operation. Lever in right position lifts printhead from paper for loading or paper pulling.
12	Keylock. Secures front panel in locked shut position.
13*	Finger Groove. Access to grasp and pull paper out for viewing. (Note: Printhead control must be in LOAD position before paper is pulled.)
14	Printer Door Latch. Moves to right to unlock printer door.
15	Function Keys. Used to select options that appear on bottom of screen. Function selected varies with screen displayed.
*Part of PP1 with printer.	

# Rear Panel

## Diagram

## Model PP1

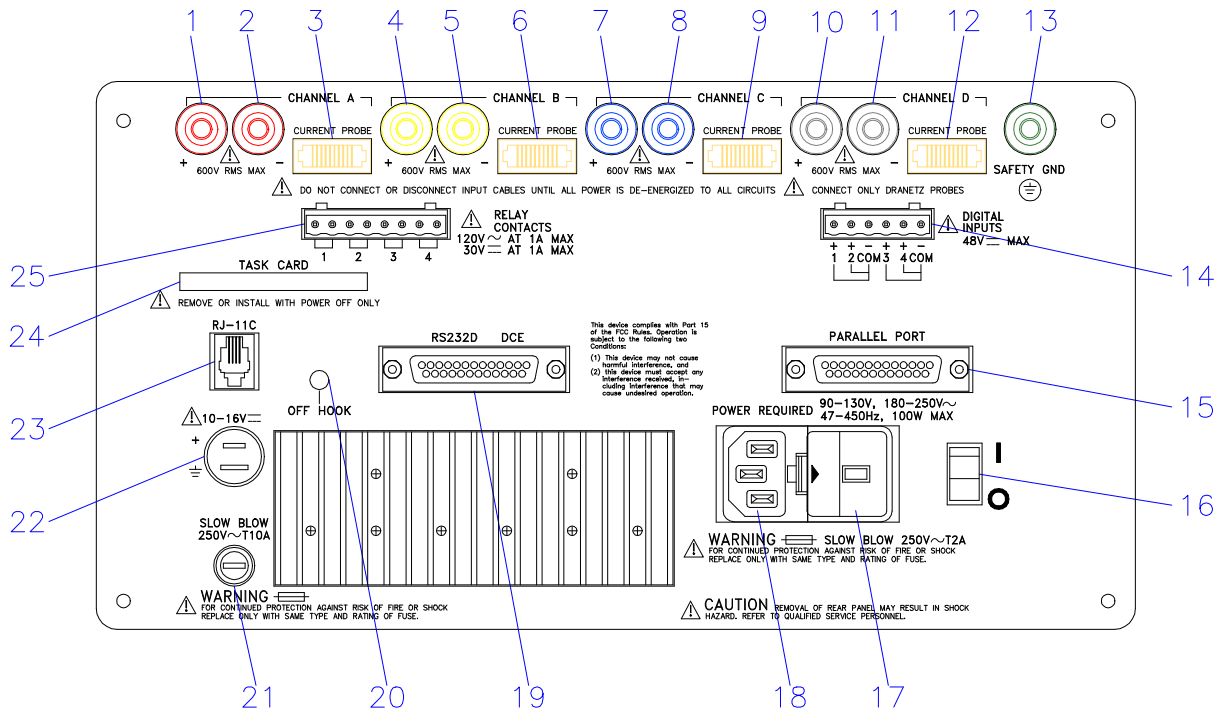

8600-15

Continued on next page



# Rear Panel, Continued

Diagram

Model PP1E

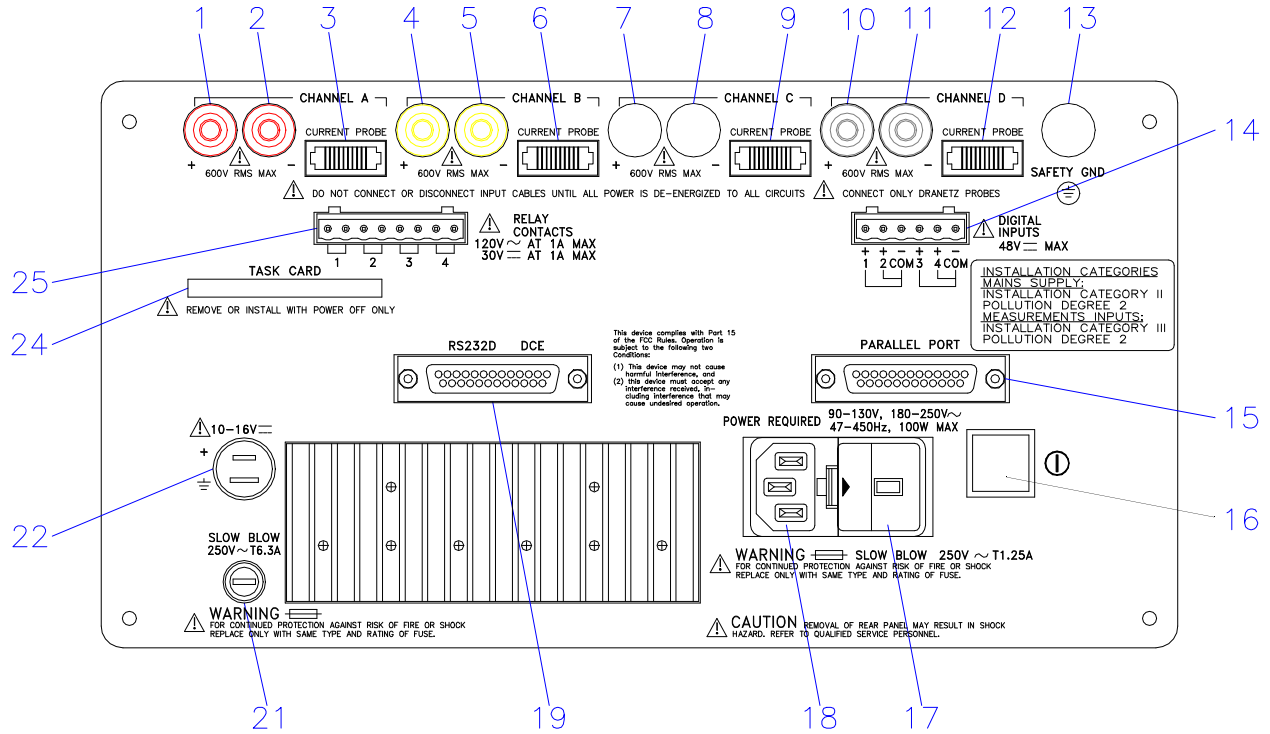

3600-62

Continued on next page

## Rear Panel, Continued

### Parts Table

Models PP1 & PP1E

Part	Description
1	CHANNEL A, + Differential Voltage Input Connector; color red.
2	CHANNEL A, - Differential Voltage Input Connector; color white.
3	CHANNEL A, CURRENT PROBE Input Connector.
4	CHANNEL B, + Differential Voltage Input Connector; color yellow.
5	CHANNEL B, - Differential Voltage Input Connector; color white.
6	CHANNEL B, CURRENT PROBE Input Connector.
7	CHANNEL C, + Differential Voltage Input Connector; color blue.
8	CHANNEL C, - Differential Voltage Input Connector; color white.
9	CHANNEL C, CURRENT PROBE Input Connector.
10	CHANNEL D, + Differential Voltage Input Connector; color grey.
11	CHANNEL D, - Differential Voltage Input Connector; color white.
12	CHANNEL D, CURRENT PROBE Input Connector.
13	SAFETY GROUND Connector; color green.
14	DIGITAL INPUTS, 12-48 VDC. Four channels of digital signal inputs.
15*	PARALLEL PORT, Parallel data port.
16	On/Off Switch. 1 = ON, 0 = OFF.
17#	PP1: SLOW BLOW 250 VAC T2A. Fuseholder. (Main Power) PP1E: SLOW BLOW 250 VAC T1.25A 5x20 mm Fuseholder (Main Power).
18	POWER REQUIRED, 90-130 VAC 180-250 VAC, 47-450 Hz, 100 W MAX. Input power plug.
19*	RS232D DCE, Serial data port.
20*	PP1: OFF HOOK indicator. When lit yellow indicates that the telephone line is active. PP1E: Not available.
21#	PP1: SLOW BLOW, 250 VAC T10A. Internal/External battery fuse. PP1E: SLOW BLOW, 250 VAC T6.3A 5x20 mm Internal/External battery fuse.

*Continued on next page*

## Rear Panel, Continued

**Parts Table**  
(continued)

---

<b>Part</b>	<b>Description</b>
22	10-16VDC, External DC voltage source input.
23*	PP1: RJ-11C. Telephone jack for internal 2400 baud modem connection. PP1E: Not Available
24	TASK CARD, connector slot.
25*	RELAY CONTACTS, 120 VAC AT 1A MAX, 30 VDC AT 1A MAX. Four sets of relay contacts.
*Not used with Inrush TASKCard. # Refer to Appendix D for Fuse Replacement.	

## Positioning the Unit

---

**Handle release** Handle releases, in the pivots of the handles, must be pressed inwards together to unlock the handles. Once released, the handles can be positioned in three positions: one for carrying the unit, and two for viewing the display at 15 or 45 degrees. At each position the handles will lock and must be released again to be repositioned.

---

**Handle release location and carrying position**

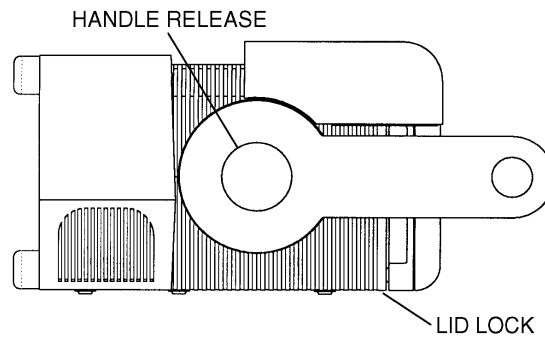

**Viewing positions**

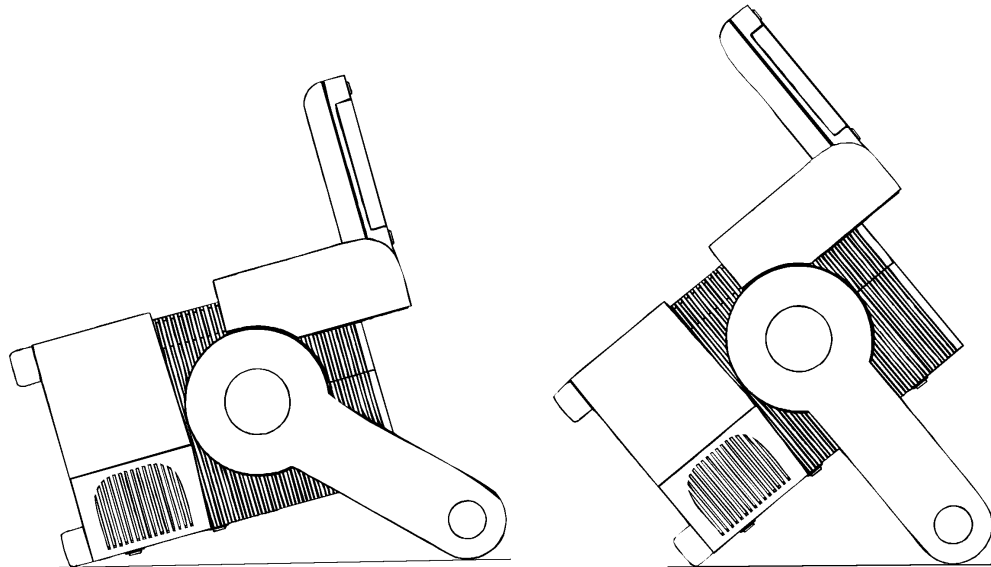

# Chapter 3

## Getting Started

### Overview

---

**What is getting started?** This chapter helps you to get started in making the required connections to the circuit to be monitored, verify that your connections are made correctly, and view the basic displays of the parameters being monitored.

---

**In this chapter** This chapter is divided into four sections.

Section	Title	See Page
A	Turn On Procedures	3-2
B	Voltage and Current Cable Connections	3-11
C	Connection Diagrams	3-34
D	Scope and Meter Mode	3-46

---

# Section A

## Turn On Procedures

### Overview

---

**Introduction** This section describes the procedures you need to perform before you turn the unit on and what you should see after it is on. Possible error conditions and the necessary corrective actions are also discussed.

---

**In this section** The following topics are covered in this section.

Topic	See Page
Setting the Voltage Selector	3-3
Power Requirements	3-5
Installing a TASKCard	3-6
Turning the Unit On	3-7

---

# Setting the Voltage Selector

**Introduction** The Power Platform input voltage may be set to 115VAC or 230VAC by manually positioning a selector type switch. The selected operating voltage is indicated in a window of the fuse holder.

**WARNING** The power to the Power Platform must be off when changing the voltage selector.

**ADVERTENCIA** Se debe cortar la energía a la Plataforma de energía cuando se cambie el selector de voltaje.

**AVERTISSEMENT** L'alimentation jusqu'à la plate-forme d'alimentation doit être coupée lors du changement de tension.

**WARNUNG** Die Stromzufuhr zur "Power Platform" (Stromplattform) muß ausgeschaltet sein, wenn der Spannungswähler ausgewechselt wird.

**Procedure** Follow these steps to set the voltage selector.

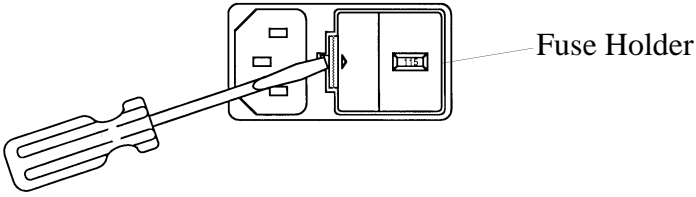
Step	Action
1	Turn power switch off and remove power cord, if connected.
2	Place screwdriver blade in fuse holder retaining slot and push to right to release fuse holder. <div style="text-align: center; margin-top: 20px;">  <p data-bbox="1101 1423 1263 1455">Fuse Holder</p> <p data-bbox="565 1612 641 1640">8600-56</p> </div>
3	Remove fuse holder.

## Setting the Voltage Selector Continued

### Procedure (continued)

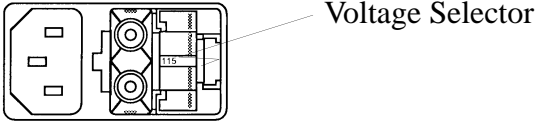
Step	Action
4	Grasp and pull out voltage selector from fuse holder body.   <p style="text-align: center;">8600-57</p>
5	Rotate voltage selector so that desired voltage marking is facing rear of panel.
6	Insert voltage selector into fuse holder slot and push firmly to seat.
7	Replace fuse holder.
8	Verify that voltage selector indicator displays the required voltage. If not, repeat steps 2 through 7.



# Power Requirements

---

## Introduction

The Power Platform can be operated from an AC or DC power source. Refer to Appendix H for information about connecting to an external DC power source.

---

## Connecting to an AC power source

Follow these steps to connect to an AC power source.

Step	Action
1	Verify that the power switch is off. See rear panel, page 2-4, item 16.
2	Verify that the voltage selector on the rear panel is set to the operating voltage of your facility. If voltage selection is wrong, refer to page 3-3.
3	Connect female end of correct operating voltage power cord (listed below) to the AC power input receptacle on the rear panel. <ul style="list-style-type: none"><li>• 115 VAC power cord - Part No. 110893-G1 (Domestic)</li><li>• 230 VAC power cord - Part No. 110726-G1 (Domestic)</li><li>• 230 VAC power cord - Part No. 115369-G1 (Euro)</li><li>• 230 VAC power cord - Part No. 115368-G2 (UK)</li></ul>
4	Connect male end of power cord to input power source.

---

## Operating the PP1 using the internal battery

Follow these steps to run the Power Platform on the internal battery.

Step	Action
1	Turn the unit off.
2	Disconnect AC power cord.
3	Turn on power to the unit.  <u>Note:</u> The unit will operate up to one hour without using the printer. Using the printer continuously will deplete the battery in approximately 15 minutes.

---

## Installing a TASKCard

### Procedure

Follow these steps to install a TASKCard.

Step	Action
1	Turn off power to the unit.
2	Remove TASKCard-INRUSH from its protective holder and check that the plug end of card is clean and free of any obstruction.  <u>Note:</u> If plug end of card is dirty, clean with static-free, dry, low pressure air to remove any foreign material causing obstruction of the plug holes.
3	Verify that the Write Protect switch (end opposite plug) is set to the Write Protect position. Use pencil point to move switch.
4	At the rear of the unit, position the TASKCard-INRUSH with the label facing up and the plug end facing the TASK CARD slot.
5	Insert the card fully into the slot until resistance is felt, then press firmly until the card engagement is felt.  <u>Note:</u> Do not force the card further into the slot if no card engagement is felt. Remove card and check that there is no foreign object on or in the plug end of the card. Remove any obstruction. Reinsert card and repeat card engagement. If card cannot be engaged, STOP all further action and call Dranetz-BMI Service for further instructions.
6	To prevent the inserted TASKCard from being removed during operation, install the TASKCard cover accessory (shown below) over the TASKCard and secure the cover with the two screws provided.
7	Go to next page for power turn on procedure.

**TASKCard  
cover  
(P/N 115818-G1)**

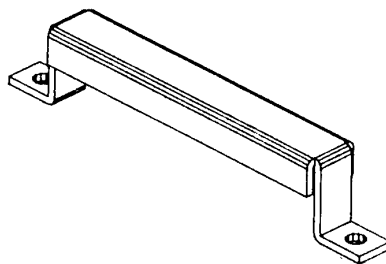

## Turning the Unit On

---

**WARNING** Do not turn power on unless a secure safety ground, using the green safety wire, is connected to the green ground terminal on the rear panel.

---

**ADVERTENCIA** No encienda la energía a menos de que haya una conexión a tierra de seguridad, utilizando el alambre de seguridad verde, con el terminal de conexión a tierra verde en el panel posterior.

---

**AVERTISSEMENT** Ne pas mettre sous tension sauf si une mise à la terre adéquate, en utilisant le câble vert de sécurité, est connectée à la borne de mise à la terre verte sur le panneau arrière.

---

**WARNUNG** Schalten Sie den Strom nicht ein, bevor Sie eine sichere Erdung mit dem grünen Erdungsdraht hergestellt haben, der an den grünen Erdungsterminal auf der Rückwand angeschlossen ist.

---

**Procedure** Follow these steps when turning on the Power Platform.

Step	Action
1	Verify that the green grounding connector is attached to the Safety Gnd connector on the rear panel and that the other end is firmly attached to a secure ground.
2	Verify that all voltage probe connections at the source or load are secure and that voltage probes are connected securely to the rear panel.
3	Verify that all current probe connections at the source or load are secure and that current probes are connected securely to the rear panel.
4	Verify that the PQPlus TASKCard is installed in the rear panel.

---

*Continued on next page*

## Turning the Unit On, Continued

### Procedure (continued)

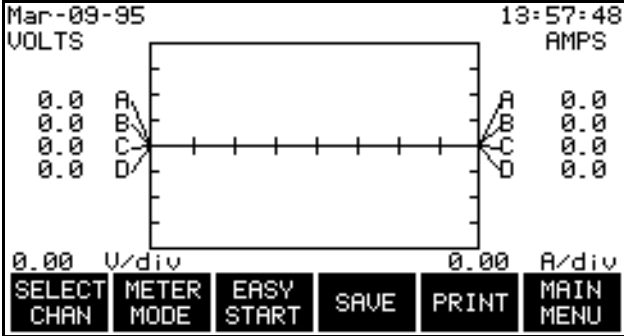
Step	Action
5	<p>Turn on power to the unit.</p> <p><u>Result:</u> If the TASKCard is inserted correctly, the unit will perform internal diagnostics, momentarily display the message “TASKCard Found, Loading PQPlus Vxx”, then display the scope mode screen shown below.</p>  <p><u>Note:</u> If the TASKCard is not inserted correctly, or if the TASKCard is corrupted, an error message will be displayed indicating TASKCard or downloading failure. Refer to the error message table on next page for the error message types and what to do next.</p>

**TASKcard error messages** The following table describes the possible error messages when loading the TASKCard and the corrective action to take for each.

Error Message	What to Do Next
TASKCard Not Found. Booting From ROM.	TASKCard may not be installed or is installed incorrectly. Turn off power and recheck TASKCard installation. To boot from ROM see next page.

*Continued on next page*

## Turning the Unit On, Continued

### TASKcard error messages (continued)

Error Message	What to Do Next
Corrupt TASKCard. Booting from ROM.	A TASKCard was found but it was not recognized as a valid TASKCard. Turn off power and recheck TASKCard. If the TASKCard is properly inserted, there may be a problem, notify Dranetz-BMI. To boot from ROM, see next page.
<p><b>WARNING:</b> The TASKCard found: (now installed) Is different than last used: (previous TASKCard) <b>CHANGING TASKCARDS MAY ERASE MEMORY!</b></p> <p><b>ADVERTENCIA:</b> La TASKCard que se encontró: (ahora instalada) Es diferente de la utilizada la última vez: (TASKCard anterior) ¡CAMBIAR LAS TASKCARDS PUEDE BORRAR LA MEMORIA!</p> <p><b>AVERTISSEMENT:</b> La TASKCard détectée : (actuellement installée) est différente de la dernière utilisée : (TASKCard précédente) <b>LE CHANGEMENT DE TASKCARDS PEUT EFFACER LA MÉMOIRE !</b></p> <p><b>WARNUNG:</b> Die gefundene TASKCard: (jetzt installiert) ist unterschiedlich von der zuletzt benutzen: (vorherige TASKCard) <b>WECHSELN DER TASKCARDS KANN SPEICHER LÖSCHEN!</b></p>	<p>Press any key to continue or turn off the unit and reinstall the last TASKCard used.</p> <p>Pulse cualquier tecla para continuar o apague la unidad y vuelva a instalar la última TASKCard utilizada.</p> <p>Appuyez sur une touche pour continuer ou éteignez l'unité et réinstallez la dernière TASKCard utilisée.</p> <p>Betätigen Sie eine Taste, um fortzufahren oder schalten Sie die Einheit aus und installieren Sie die zuletzt benutzte TASKCard erneut.</p>
<p>Any of the following:</p> <ul style="list-style-type: none"> <li>•I/O Processor Download Failed</li> <li>•ACP Processor Download Failed</li> <li>•I/O Processor Will Not Respond</li> <li>•ACP Processor Will Not Respond</li> </ul>	TASKCard download problem. Notify Dranetz-BMI for further assistance.

## Turning the Unit On, Continued

### When to boot from ROM

Boot from ROM under the following conditions:

- you have a problem loading the TASKCard, or
- you want to operate the power platform without the TASKCard.

### Booting from ROM

To boot from ROM proceed as follows:

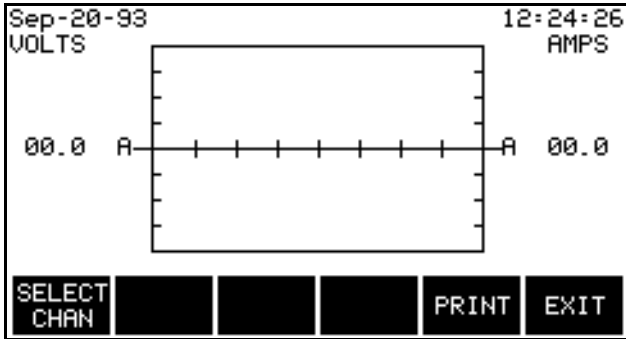
Step	Action
1	<p>From the error message screen, press any key. The following screen is displayed.</p> 
2	Press EXIT to display the Meter Mode Menu.

### Available Functions

When you boot from ROM, only the following functions are available.

Function	See Page
One Channel, All Parameters Meter All Channels, One Parameter Meter	3-50
Scope Mode	3-47
Voltage and Current Phasors	3-52
Set Time and Date	4-4

### Note

No further monitoring or displaying of parameter data is possible without having a TASKCard installed.

## Section B

### Voltage and Current Cable Connections

#### Overview

---

**Introduction** This section covers topics related to the connection of the various voltage and current devices that can be used when making measurements. For specific circuit applications, refer to Section C.

---

**WARNING** **Death, serious injury, or fire hazard could result from improper connection of this instrument. Read and understand this manual before connecting this instrument. Follow all installation and operating instructions while using this instrument.**

**Connection of this instrument must be performed in compliance with the National Electrical Code (ANSI/NFPA 70-1996) of USA and any additional safety requirements applicable to your installation.**

**Installation, operation, and maintenance of this instrument must be performed by qualified personnel only. The National Electrical Code defines a qualified person as “one familiar with the construction and operation of the equipment and the hazards involved.”**

---

**ADVERTENCIA** **Una conexión incorrecta de este instrumento puede producir la muerte, lesiones graves y riesgo de incendio. Lea y entienda este manual antes de conectar. Observe todas las instrucciones de instalación y operación durante el uso de este instrumento.**

**La conexión de este instrumento debe ser hecha de acuerdo con las normas del Código Eléctrico Nacional (ANSI/NFPA 70-1996) de EE. UU., además de cualquier otra norma de seguridad correspondiente a su establecimiento.**

**La instalación, operación y mantenimiento de este instrumento debe ser realizada por personal calificado solamente. El Código Eléctrico Nacional define a una persona calificada como "una que esté familiarizada con la construcción y operación del equipo y con los riesgos involucrados."**

---

## Overview, Continued

---

### AVERTISSE- MENT

**Si l'instrument est mal connecté, la mort, des blessures graves, ou un danger d'incendie peuvent s'en suivre. Lisez attentivement ce manuel avant de connecter l'instrument. Lorsque vous utilisez l'instrument, suivez toutes les instructions d'installation et de service.**

**Cet instrument doit être connecté conformément au National Electrical Code (ANSI/NFPA 70-1996) des Etats-Unis et à toutes les exigences de sécurité applicables à votre installation.**

**Cet instrument doit être installé, utilisé et entretenu uniquement par un personnel qualifié. Selon le National Electrical Code, une personne est qualifiée si "elle connaît bien la construction et l'utilisation de l'équipement, ainsi que les dangers que cela implique".**

---

### WARNUNG

**Der falsche Anschluß dieses Gerätes kann Tod, schwere Verletzungen oder Feuer verursachen. Bevor Sie dieses Instrument anschließen, müssen Sie die Anleitung lesen und verstanden haben. Bei der Verwendung dieses Instruments müssen alle Installation- und Betriebsanweisungen beachtet werden.**

**Der Anschluß dieses Instruments muß in Übereinstimmung mit den nationalen Bestimmungen für Elektrizität (ANSI/NFPA 70-1996) der Vereinigten Staaten, sowie allen weiteren, in Ihrem Fall anwendbaren Sicherheitsbestimmungen, vorgenommen werden.**

**Installation, Betrieb und Wartung dieses Instruments dürfen nur von Fachpersonal durchgeführt werden. In dem nationalen Bestimmungen für Elektrizität wird ein Fachmann als eine Person bezeichnet, welche "mit der Bauweise und dem Betrieb des Gerätes sowie den dazugehörigen Gefahren vertraut ist."**

---

### Safety precautions

The following safety precautions must be followed whenever any type of connection is being made to the instrument.

- Connect the green safety (earth) ground first, before making any other connections.
- When connecting to electric circuits or pulse initiating equipment, open their related breakers. DO NOT install any connection of the instrument on live power lines.

---

*Continued on next page*



## Overview, Continued

---

- Connections must be made to the instrument first, then connect to the circuit to be monitored.
  - Wear safety glasses and insulated gloves when making connections to power circuits.
  - Hands, shoes and floor must be dry when making any connection to a power line.
  - Make sure the unit is turned OFF before connecting probes to the rear panel.
  - Before each use, inspect all cables for breaks or cracks in the insulation. Replace immediately if defective.
- 

### Medidas de seguridad

Las medidas de seguridad siguientes deberán observarse cuando se realice cualquier tipo de conexión al instrumento.

- Antes de hacer cualquier conexión, deberá enchufarse el conector de seguridad verde a tierra.
  - Cuando se haga conexiones a circuitos eléctricos o a equipo de activación por pulso, deberá abrirse sus respectivas cajas de seguridad. NO deberá hacerse ninguna conexión del instrumento en líneas eléctricas bajo tensión.
  - Las conexiones deberán hacerse primero al instrumento y, luego, al circuito a ser monitorizado.
  - Al hacer conexiones a circuitos eléctricos, deberá utilizar anteojos y guantes protectores.
  - Sus manos, zapatos y el piso deberán estar secos en todo momento en que se haga una conexión a un cable eléctrico.
  - Verifique que la unidad esté DESACTIVADA antes de conectar sondas en el panel posterior.
  - Previo a cada uso, deberá verificarse que los cables no estén rotos y que el material aislante no tenga rajaduras. Reemplace de inmediato cualquier parte defectuosa.
- 

### Mesures de Sécurité

Les mesures de sécurité suivantes doivent être prises chaque fois qu'un type de connexion quelconque est effectué sur l'instrument.

- Connecter d'abord la prise de terre de sécurité verte (terre) avant d'effectuer toute autre connexion.
  - Ouvrir les disjoncteurs correspondants lors d'une connexion à des circuits électriques ou à des équipement de génération d'impulsions. NE PAS effectuer de connexion d'instrument sur des lignes électriques sous tension.
  - Une fois toutes les connexions de l'instrument effectuées, connecter au circuit à contrôler.
- 

*Continued on next page*

## Overview, Continued

- 
- Porter des lunettes de protection et des gants isolants pour effectuer des connexions aux circuits électriques.
  - S'assurer que les mains, les chaussures et le sol soient secs lors de connexions à une ligne électrique.
  - S'assurer que l'unité est ÉTEINTE avant de connecter les sondes au panneau arrière.
  - Inspecter tous les câbles, avant chaque utilisation, pour s'assurer que les isolants ne sont pas coupés ou fendus. Remplacer immédiatement tous les équipements défectueux.
- 

### Sicherheitsvorkehrungen

Die folgenden Sicherheitsvorkehrungen sind immer dann zu befolgen, wenn eine Verbindung zum Instrument hergestellt wird.

- Schließen Sie zuerst die grüne Sicherheits-/Erdleitung an, bevor Sie eine andere Verbindung herstellen.
  - Öffnen Sie beim Anschluß an elektrische Stromkreise oder Impulsauslösungseinrichtungen die entsprechenden Unterbrecher. Es dürfen KEINE Anschlüsse an das Instrument unter stromführenden Spannungsleitungen montiert werden.
  - Die Verbindungen müssen zuerst am Instrument und danach an der zu überwachenden Schaltung hergestellt werden.
  - Tragen Sie Schutzbrillen und Isolierhandschuhe, wenn Sie Anschlüsse an den Stromkreisen vornehmen.
  - Hände, Schuhe und Fußboden müssen trocken sein, wenn Sie Anschlüsse an den Stromkreisen durchführen.
  - Stellen Sie sicher, daß das Gerät AUSgeschaltet ist, bevor Sie an der rückwärtigen Konsole Meßfühler anschließen.
  - Prüfen Sie vor jedem Gebrauch alle Kabel auf Bruchstellen und Risse in der Isolierung. Wechseln Sie schadhafte Kabel sofort aus.
- 

### In this section

The following topics are covered in this section.

Topic	See Page
Connecting a Voltage Probe	3-15
Connecting to a Potential Transformer (PT)	3-19
Connecting a Current Probe	3-21
Connecting to a Current Transformer (CT)	3-26
Connecting to an Isolated Current Transformer (ISO)	3-28

---

## Connecting a Voltage Probe

---

**Safety precautions**

Follow the safety precautions listed on page 3-12 when making all voltage probe connections.

---

**Medidas de seguridad**

Siga las medidas de seguridad listadas en la página 3-13 cuando efectúe todas las conexiones potenciales del transformador.

---

**Mesures de sécurité**

Suivez les mesures de sécurité données en page 3-13 lors de la réalisation de toutes les connexions du transformateur de tension.

---

**Sicherheitsvorkehrungen**

Folgen Sie den auf Seite 3-14 aufgeführten Sicherheitsvorkehrungen, wenn Sie an potentiellen Trafo-Verbindungen arbeiten.

---

**Measurement cable set**

Description: Voltage probes and jumpers are provided as standard accessories and are stored in a cable pallet as part of the measurement cable set, part number 115815-G1(Domestic), 115815-G2 (Euro), or 115815-G3 (UK).

Voltage Rating: Direct connection of all voltage probes for measurement are rated at 600 Vrms max. For measuring voltages greater than 600 Vrms Potential Transformers (PT's) must be used.

Contents: The voltage cables are shown in the following figure (positioned relative to their actual use) and consist of the following:

- Eight, 8-foot channel measurement cable assemblies (probes), each with a detachable, crocodile jaw, safety clip assembly. The safety clip assemblies are red (+) and black (-) for each of the four channels. One probe assembly each of red (channel A), yellow (channel B), and blue (channel C) and five each of black are provided.
- Four 1-foot blue jumpers for input connector jumpering.

A pallet for storage of the cables and the input power cable are included in the contents of the measurement cable set but are not shown in the figure.

---

*Continued on next page*

# Connecting a Voltage Probe, Continued

## Measurement cable set

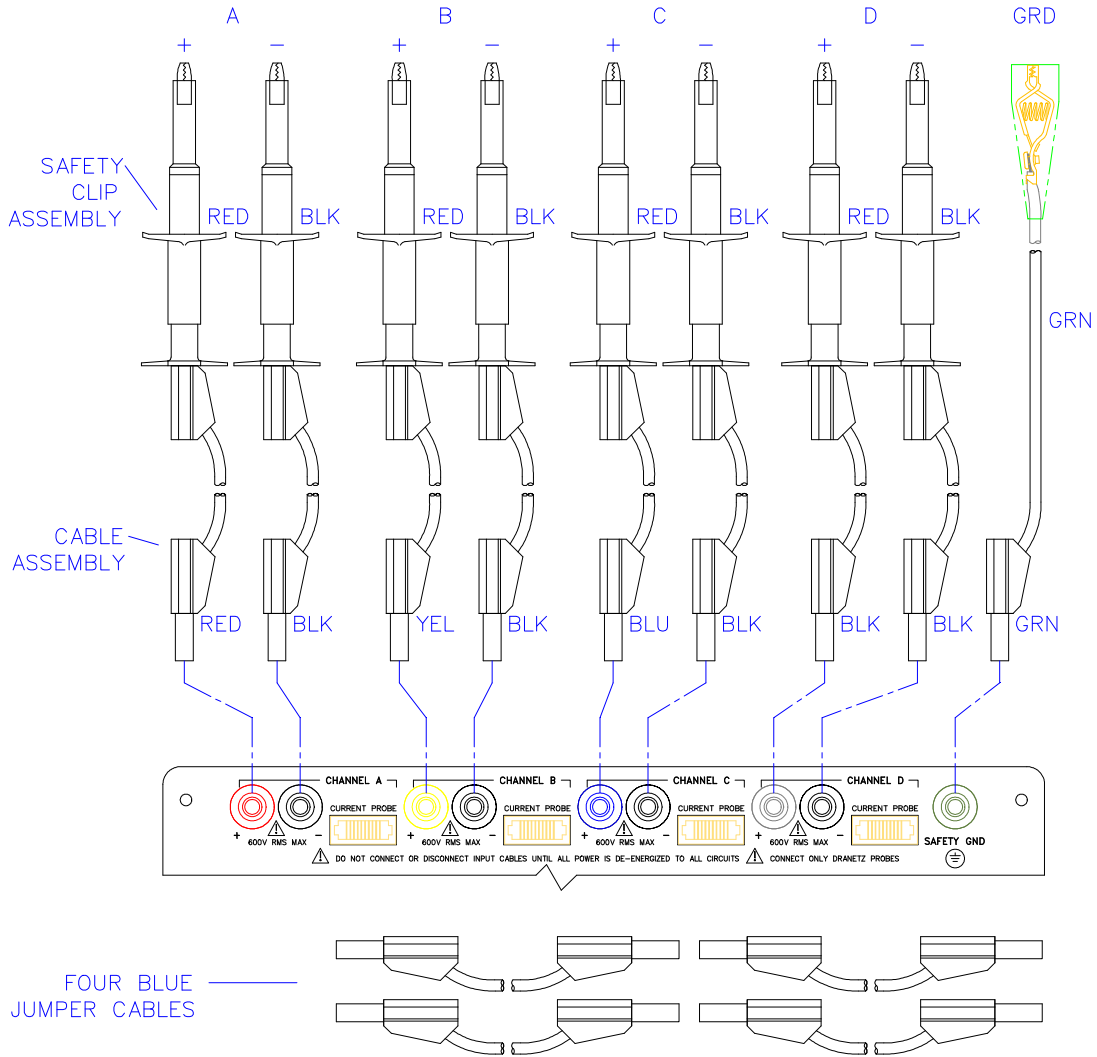

NOTE: Pallet and input power cable not shown.

8600-28A

Continued on next page

## Connecting a Voltage Probe, Continued

### Connection guidelines

Follow these guidelines when making voltage connections.

- Refer to the measurement test set figure for color coding of probes that connect to input channel connectors A, B, C, and D.
- Each channel input has plus (+) and minus (-) differential inputs of 60 to 600Vrms max. Unused voltage channel differential inputs must be jumpered together using the blue jumpers provided.
- Channel D has an additional low voltage range of 0 to 60 Vrms max. for low voltage measurements.

### Single phase connection example

The following figure shows a voltage connection to a single phase circuit for channel A. Jumpers are used to connect the differential inputs of channels B, C, and D together as shown to prevent erroneous data. The green cable is always connected to a secure ground (earth) connection as a safety ground.

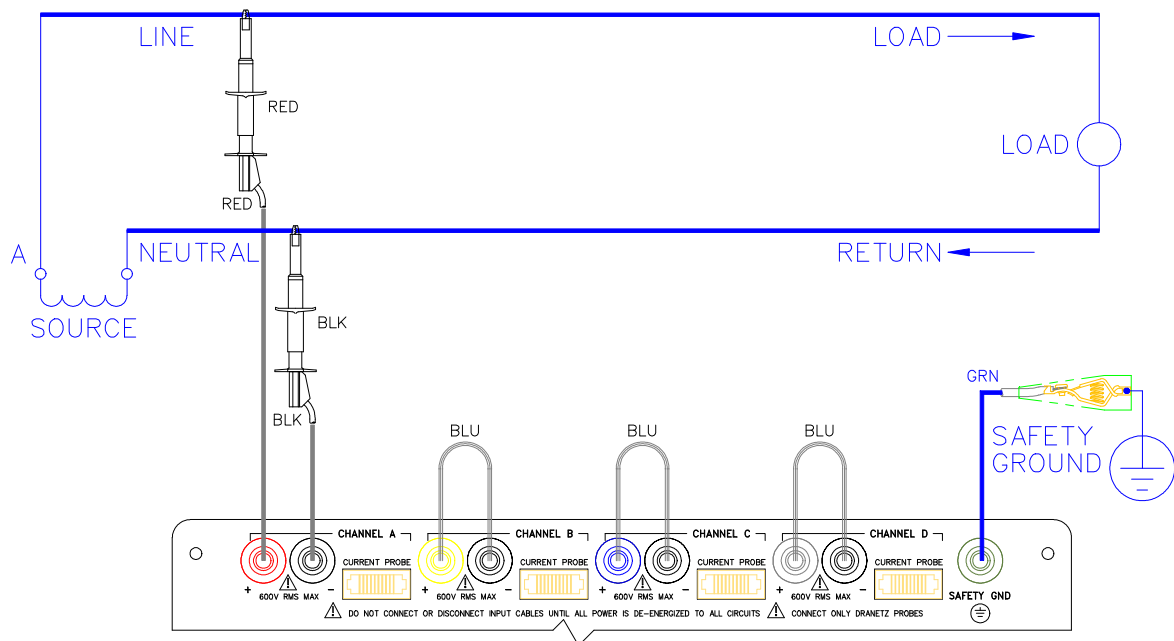

8600-18

*Continued on next page*

## Connecting a Voltage Probe, Continued

### Neutral to ground connection example

The following figure shows a voltage connection using channel D as a differential input for a single phase connection. Connections are identical for split phase, delta, and wye configurations. One probe connects the source neutral line to the D+ input. Another probe connects the circuit ground to the D- input. Any channel input may be used to perform this measurement but Channel D is usually used because it provides a low voltage range of 0 to 60 Vrms.

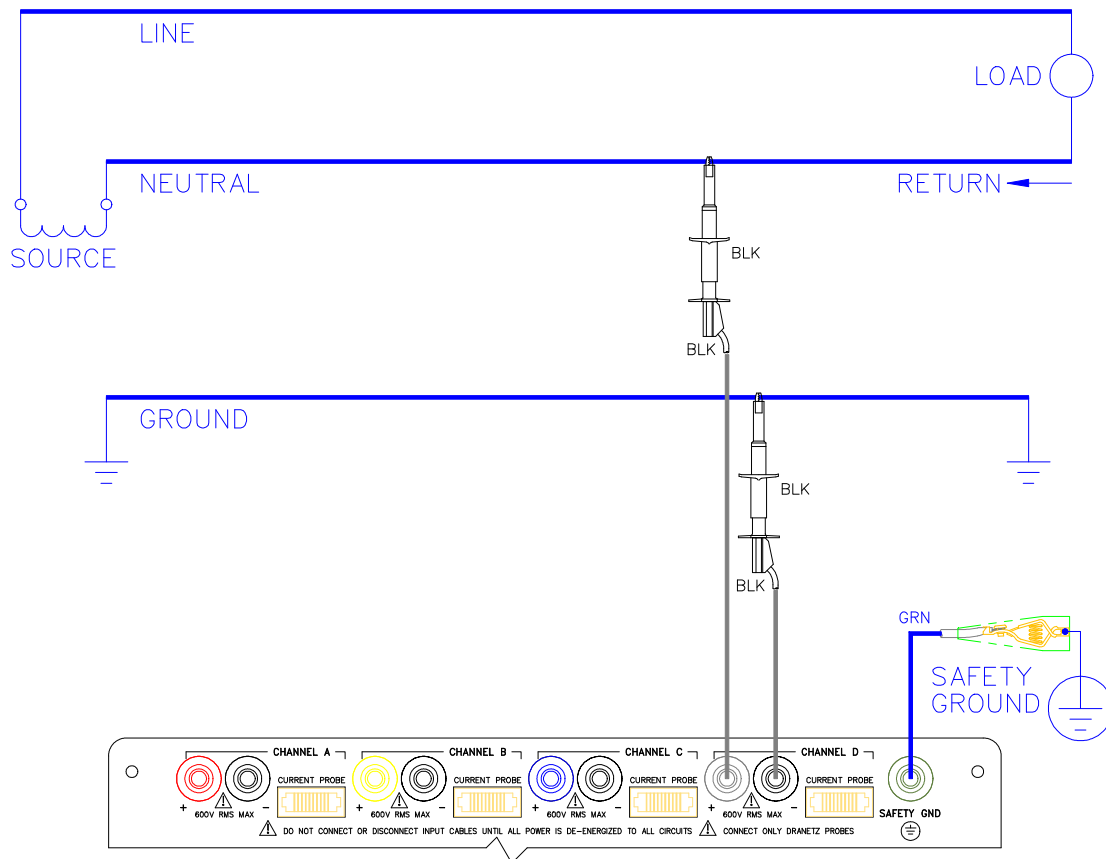

8600-19

*Continued on next page*

## Connecting to a Potential Transformer (PT)

---

**Safety precautions**

Follow the safety precautions listed on page 3-12 when making all voltage probe connections.

---

**Medidas de seguridad**

Siga las medidas de seguridad listadas en la página 3-13 cuando efectúe todas las conexiones potenciales del transformador.

---

**Mesures de sécurité**

Suivez les mesures de sécurité données en page 3-13 lors de la réalisation de toutes les connexions du transformateur de tension.

---

**Sicherheitsvorkehrungen**

Folgen Sie den auf Seite 3-14 aufgeführten Sicherheitsvorkehrungen, wenn Sie an potentiellen Trafo-Verbindungen arbeiten.

---

**Note**

Potential Transformers are not manufactured by Dranetz-BMI and are discussed here for informational purposes only.

---

**Definition**

A potential transformer (PT), also referred to as a voltage instrument transformer, provides the necessary step-down ratio to reduce the high voltage of circuits above 600V<sub>rms</sub> to a level for safe measurement. A PT also provides isolation and proper connections for instrument attachment.

---

**Connections**

PT's are usually fixed in position and require that the voltage probe(s) be connected to their terminal connections.

---

**WARNING**

**Refer to the manufacturer's instructions, related to the PT, for exact information for probe connection for voltage monitoring. Do not exceed 600V<sub>rms</sub> input to the PP1 voltage inputs.**

---

**ADVERTENCIA**

**Consulte las instrucciones del fabricante referentes a TP (transformador potencial), para la información exacta de la conexión de sonda a fin de monitorear el voltaje. No supere la entrada de 600 V<sub>rms</sub> a las entradas de voltaje de PP1.**

---

*Continued on next page*

## Connecting to a Potential Transformer (PT), Continued

---

### AVERTISSEMENT

Se reporter aux instructions du fabricant relatives au transformateur de tension (Potential Transformer - PT) pour obtenir les renseignements exacts sur la connexion de sonde utilisée pour la surveillance du courant. Ne pas dépasser l'entrée de tension efficace de 600 RMS dans les entrées de tension de PP1.

---

### WARNUNG

Genaue Informationen zur Meßfühlerverbindung für die Spannungsüberwachung entnehmen Sie bitte den Anleitungen des Herstellers (siehe Spannungsteilertransformator). Die Eingangsspannung von 600 V (Effektivwert) in die PP1 Spannungseingänge sollte nicht überschritten werden.

---

### Procedure

Follow these steps to connect voltage probes to a potential transformer.

Step	Action
1	Turn off power to the PT.
2	Connect the green ground connector to the Safety Gnd connector on the rear panel of the Power Platform.
3	Connect the green ground connector to a solid ground point at or near the PT in accordance with the PT manufacturer's instructions.
4	Connect the colored voltage probes to the PT's connections in accordance with the manufacturer's instructions.
5	Connect the colored voltage probes to the channel inputs designated for monitoring.
6	Turn on power to the PT.

---

### Scale factor

The scale factor of the PT must be accounted for in making accurate voltage measurements. Because the monitored output voltage of the PT is stepped-down (divided) from the original voltage, this ratio must be stepped-up (multiplied) by the PP1-Inrush when voltage computations are performed. The PT scale factor is usually mounted on the PT assembly and is entered into the PP1-Inrush on the scale factors screen (refer to Chapter 5). Refer to the PT manufacturer's literature for definition of the scale factors.

---



## Connecting a Current Probe

---

### Safety precautions

The following safety precautions apply to current probe connections in addition to those safety precautions stated on page 3-12.

- DO NOT attempt to measure current in any circuit in which the circuit to ground voltage exceeds the insulation rating of the current probe (600 Vrms max).
  - Make sure the jaws of the current probe are tightly closed. Keep mating surfaces clean and free from foreign matter.
- 

### Medidas de seguridad

Las siguientes medidas de seguridad se aplican a las conexiones de la sonda actual además de las precauciones de seguridad que aparecen en la página 3-13.

- NO deberá intentar medir la corriente eléctrica en ningún circuito en que el voltaje del mismo a tierra sea mayor al promedio de aislamiento de la sonda eléctrica (600 Vrms máx).
  - Verifique que la mordaza de la sonda eléctrica esté bien apretada. Mantenga las superficies de fusión limpias y libres de materia extraña.
- 

### Mesures de sécurité

Les mesures de sécurité suivantes doivent être respectées en plus des consignes de sécurité données en page 3-13 lors de la réalisation de connexions de sondes.

- NE PAS essayer de mesurer le courant dans un circuit où la tension est supérieure au régime d'isolation de la sonde (600 Vrms max.).
  - S'assurer que les mâchoires de la sonde sont bien serrées. S'assurer que la surface de contact est propre et exempte de corps étrangers.
- 

### Sicherheitsvorkehrungen

Die folgenden Sicherheitsvorkehrungen treffen auf derzeitige "Probe"-Verbindungen zu und gelten zusätzlich zu den Sicherheitsmaßnahmen auf Seite 3-14.

- Versuchen Sie NICHT, den Strom in einem Schaltkreis zu messen, in dem der Durchgang zur Erdspannung den Isolierwert des Spannungsmeßfühlers (600 Volt Effektivwert) übersteigt.
  - Stellen Sie sicher, daß die Klemmbacken des Spannungsmeßfühlers fest geschlossen sind. Halten Sie die zusammengehörigen Oberflächen sauber und frei von Fremdteilen.
- 

*Continued on next page*

## Connecting a Current Probe, Continued

---

**Types of current probes** Several types of current probes<sup>1</sup> (clamp-on current transformers) are available as optional accessories. These probes are shown in the figure on the next page and consist of the smallest current probe (Dranetz-BMI model CT10), used to monitor up to 10 amps rms max, to the largest current probe (Dranetz-BMI model CT3000) for measurements up to 3000 amps rms max.

Refer to Appendix F for complete probe specifications.

---

**WARNING** When using either the CT-10 or CT-150 current probe, **DO NOT** connect the probe jaws around a non-insulated wire. These probes are to be used to monitor current of insulated wire only.

---

**ADVERTENCIA** Cuando use la punta de prueba de corriente CT-10 o CT-150, **NO** sujete las mandíbulas de la punta alrededor de un cable sin aislación. Esta punta se usa para mediciones en cables aislados solamente.

---

**AVERTISSEMENT** Lorsque vous utilisez la sonde de courant CT-10 ou CT-150, **NE FERMEZ PAS** les mâchoires de la sonde sur un fil non isolé. Cette sonde ne doit être utilisée qu'avec des fils isolés.

---

**WARNUNG** Der Stromfühler CT-10 oder CT-150 **DARF NICHT** an ein unisoliertes Kabel angeschlossen werden. Dieser Stromfühler darf nur für die Überwachung von isolierten Kabeln benutzt werden.

---

**Description** Each probe has a polarized plug to fit any one of the four current input connectors (A, B, C, or D) on the rear panel of the Power Platform.

Maximum jaw openings are described in the specifications in Appendix F.

An arrow marking on the handle is a guide to ensure that you position the probe with the arrow pointing towards the load. Correct position of the probe is necessary for correct power measurements.

---

*Continued on next page*

1. Portions of this product manufactured under license from BMI, Patent No. 5,089,979.

## Connecting a Current Probe, Continued

**Wire marker kit** The wire marker kit, supplied as a standard accessory, helps you identify which current probe is connected to each current channel input. This kit, part number 155520, contains adhesive backed color-coded marker labels to attach to the probe handle and the plug end of the probe. Use red label for channel A, yellow for B, and blue for C. Channel D is left unmarked. See figure for proper wire marker placement.

### Wire marker placement

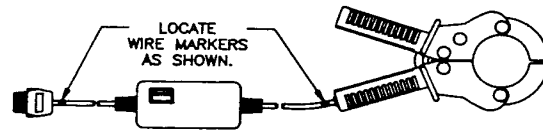

8600-62

### Dranetz-BMI current probe

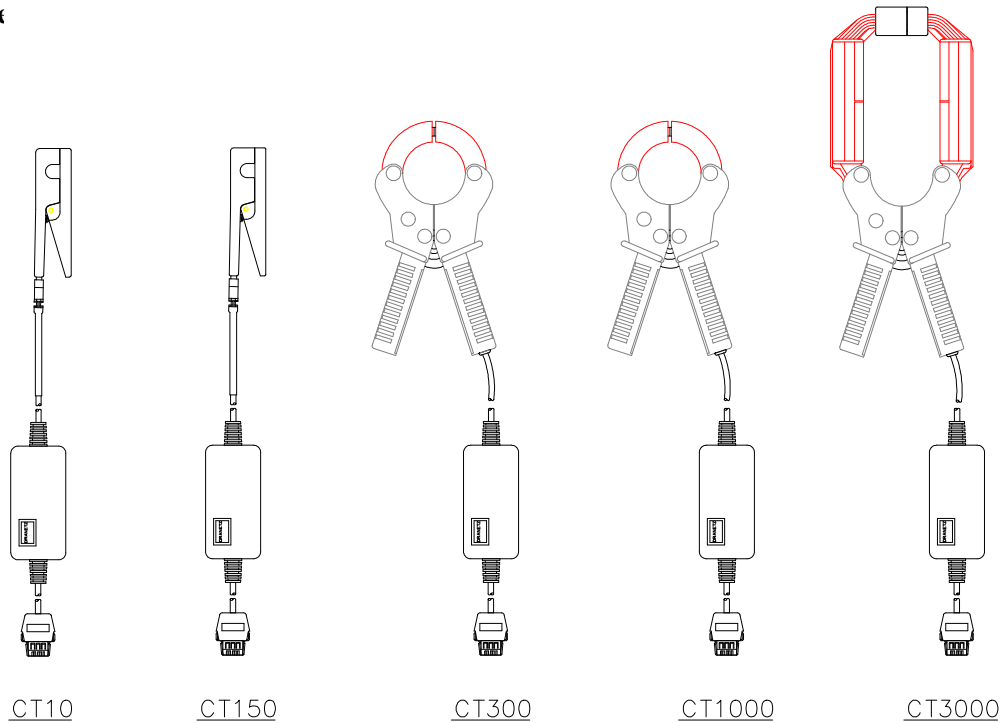

8600-21

## Connecting a Current Probe, Continued

---

### Connection guidelines

Follow these guidelines when making current connections.

- Position the probe with the arrow on the handle facing the load.
  - For greatest accuracy during steady state measurements, use a probe that is rated at no more than twice the nominal value you expect to measure.
- 

### Note

Inrush current levels can be up to 10 times nominal. To avoid current probe saturation and the possibility of inaccurate readings, select the proper size probe. Refer to Appendix F for detailed information on current probe ranges.

---

## Connecting a Current Probe, Continued

### Example

The following figure shows how to connect a current probe to channel A for current monitoring of a single phase line.

The current probe may be connected to the return line if desired to measure the return current when checking for load current leakage, loop current relationships, etc.

### Single phase current probe connection example

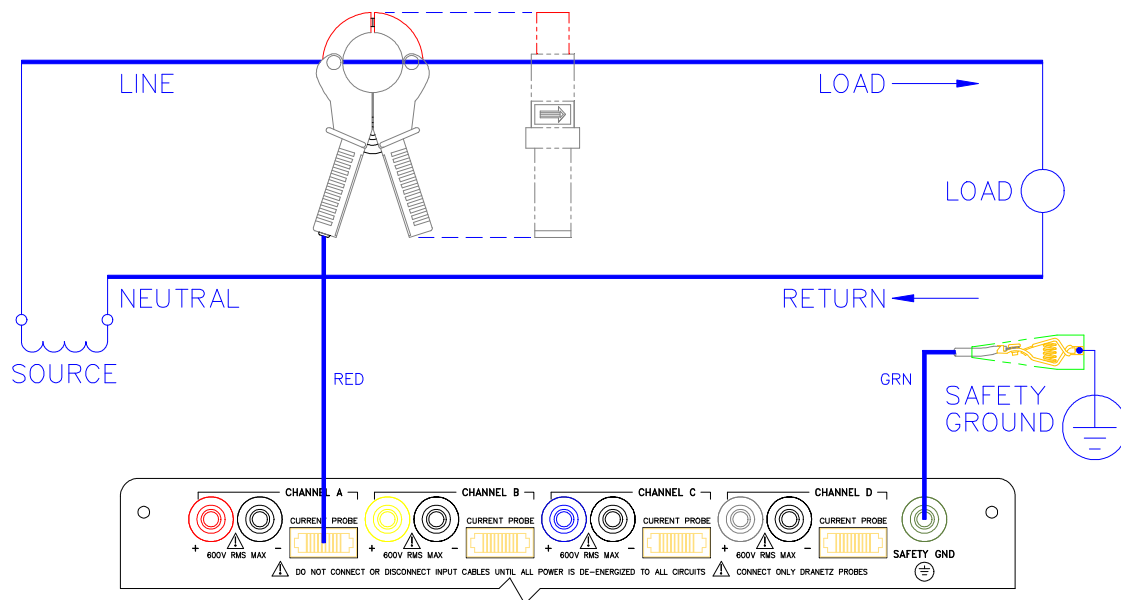

8600-20

### Note

The connection shown above is not recommended without a voltage connection to ensure frequency synchronization. If this configuration is used, then an internal frequency reference must be entered. Refer to page 5-9.

## Connecting to a Current Transformer (CT)

---

### Safety precautions

The following safety precautions apply to current transformer (CT) connections in addition to those safety precautions stated on page 3-12.

- Never energize a CT with the secondary open.
  - Never disconnect the secondary of a CT with primary energized.
- 

### Medidas de seguridad

Las medidas de seguridad siguientes corresponden a conexiones de transformadores eléctricos (CT) además de las medidas de seguridad que aparecen en la página 3-13.

- Nunca deberá poner bajo tensión un CT con el transformador secundario abierto.
  - Nunca deberá desconectar el transformador secundario de un transformador eléctrico si el transformador primario está bajo tensión.
- 

### Mesures de sécurité

Les mesures de sécurité suivantes s'appliquent aux connexions de transformateurs de couranten plus des mesures de sécurité données en page 3-13.

- Un jamais mettre un transformateur sous tension lorsque la bobine secondaire est ouverte.
  - Ne jamais déconnecter la bobine secondaire d'un transformateur lorsque la bobine primaire est sous tension.
- 

### Sicherheitsvorkehrungen

Die folgenden Sicherheitsvorkehrungen gelten für Anschlüsse an Transformatoren und gelten zusätzlich zu den Sicherheitsvorkehrungen auf Seite 3-14.

- Führen Sie einem Transformator niemals Strom zu, wenn die Niederspannungsseite geöffnet ist.
  - Lösen Sie niemals die Verbindung der Niederspannungsseite eines Transformators, wenn die Oberspannungsseite unter Strom steht.
- 

### WARNING

**Refer to the manufacturer's instructions related to the CT for exact information for connections for current monitoring. Do not exceed manufacturer's ratings.**

---

### ADVERTENCIA

**Consulte las instrucciones del fabricante referentes a TC (transformador de corriente) para la información exacta de las conexiones a fin de monitorear la corriente. No exceda las capacidades nominales del fabricante.**

---

## Connecting to a Current Transformer (CT), Continued

---

### ADVERTISSE- MENT

Se reporter aux instructions du fabricant relatives au transformateur de courant (Current Transformer - CT) pour obtenir les renseignements exacts sur les connexions utilisées pour la surveillance du courant. Ne pas dépasser la puissance recommandée par le fabricant.

---

### WARNUNG

Genaue Informationen zu Verbindungen für die Stromüberwachung entnehmen Sie bitte den Anleitungen des Herstellers (siehe Stromumwandler). Die Grenzwerte des Herstellers sollten nicht überschritten werden.

---

### Note

Current Transformers are not manufactured by Dranetz-BMI and are discussed here for informational purposes only.

---

### Description

Current transformers, also known as instrument transformers, reduce high level currents to low level currents so they can be safely monitored. These devices are similar to PT's used for voltage measurements in that both reduce values for safe measurement. The reduction, or step-down ratio, is stated as a scale factor that is used by the PP1-Inrush to step-up the measured value to its original value.

---

### Types of CT's

There are single-phase CT's and polyphase CT's dependent on the source transformer used. Current reduction ratios vary widely and are also dependent on the source transformer used. Rating plates attached to the CT provide information as to the ratio and current limitations.

---

## Connecting to an Isolated Current Transformer (ISO)

---

### Safety precautions

The following safety precautions apply to isolated current transformer connections in addition to those safety precautions stated on page 3-12.

- Never energize a CT with the secondary open.
  - Never disconnect the secondary of a CT probe with primary energized.
- 

### Medidas de seguridad

Las medidas de seguridad siguientes corresponden a conexiones de transformadores eléctricos (CT).

- Nunca deberá poner bajo tensión un CT con el transformador secundario abierto.
  - Nunca deberá desconectar el transformador secundario de un transformador eléctrico si el transformador primario está bajo tensión.
- 

### Mesures de sécurité

Les mesures de sécurité suivantes s'appliquent aux connexions de transformateurs de courant.

- Un jamais mettre un transformateur sous tension lorsque la bobine secondaire est ouverte.
  - Ne jamais déconnecter la bobine secondaire d'un transformateur lorsque la bobine primaire est sous tension.
- 

### Sicherheitsvorkehrungen

Die folgenden Sicherheitsvorkehrungen gelten für Anschlüsse an Transformatoren.

- Führen Sie einem Transformator niemals Strom zu, wenn die Niederspannungsseite geöffnet ist.
  - Lösen Sie niemals die Verbindung der Niederspannungsseite eines Transformators, wenn die Oberspannungsseite unter Strom steht.
- 

### Description

Low current monitoring devices made by Dranetz-BMI are called isolated current transformers or ISO boxes for short. Dranetz-BMI makes two types of ISO boxes; one model (ISO-1A) monitors up to 1 amp rms of current maximum, the other model (ISO-5) up to 5 amps rms maximum. Both are available as optional accessories.

---

### Warning

**Physical injury or equipment damage could result if ISO boxes are improperly connected. ISO boxes must be connected in-line (in series) only with an AC current source. Direct connection to an AC voltage may permanently damage the current transformer. Terminals X1 and X2 are each rated at 600 Vrms max to ground isolation.**

---

*Continued on next page*



## Connecting to an Isolated Current Transformer (ISO), Continued

---

**ADVERTENCIA**

**Podrían producirse lesiones físicas o daños al equipo si se conectan indebidamente las cajas del transformador aislado de corriente (ISO). No conecte una caja del ISO entre dos conductores que tengan distintos potenciales de voltaje.**

---

**AVERTISSEMENT**

**Une mauvaise connexion des transformateurs d'intensité isolés (ISO) peut provoquer des blessures corporelles ou des dégâts matériels. Ne pas relier les transformateurs ISO entre deux conducteurs de tensions différentes.**

---

**WARNUNG**

**Falsch angeschlossene ISO-Kästen (Isolierte Stromumwandler) können zu körperlichen Verletzungen oder Geräteschäden führen. Schliessen Sie einen ISO-Kasten nicht zwischen zwei Leiter mit unterschiedlichem Spannungspotential.**

---

**Applications**

ISO boxes can be used in a number of ways. These methods include connecting them to the secondary of CT's for metering by the PP1-Inrush, inserting them in series with the load current to measure low current values, and connecting them to a non-Dranetz-BMI clamp-on current transformer and using that CT to monitor current with the PP1-Inrush.

---

*Continued on next page*

## Connecting to an Isolated Current Transformer (ISO), Continued

### ISO box connection to a current transformer

The figure below shows an ISO box connected from Channel B current input to a permanently installed CT. Polarities of the ISO box and CT are kept in-phase by matching markings. Scale factors of both devices must be multiplied together to get the resultant scale factor. Refer to page 5-6 for more information about scale factors.

### ISO box connection to a CT

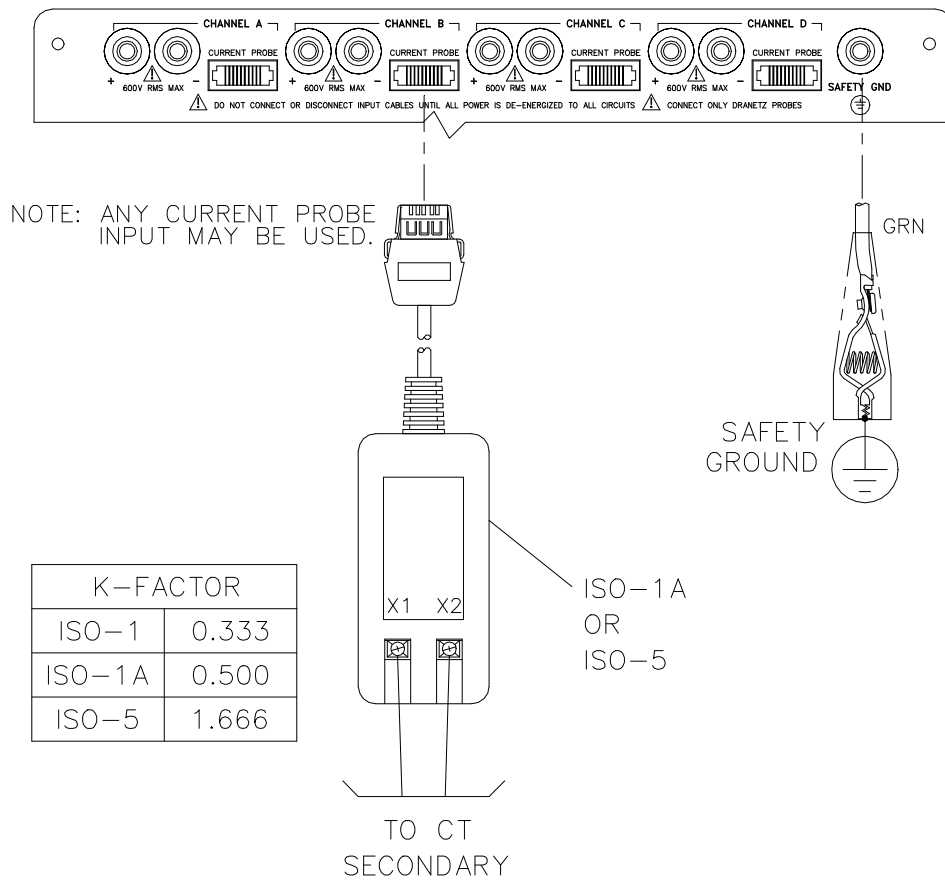

8600-24

Continued on next page

## Connecting to an Isolated Current Transformer (ISO), Continued

### ISO box in-line connection

The figure below shows the ISO box connected in series with the load of a single-phase line. The connection is made with the X1 terminal connected to the source input line and X2 connected to the load line. The scale factor is that of the ISO box only.

### ISO box connection in-line with a load

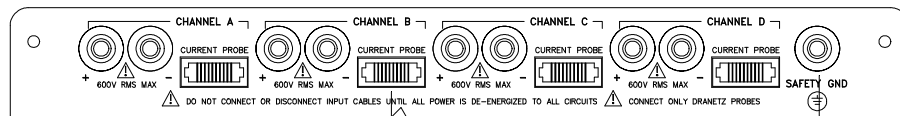

NOTE: ANY CURRENT PROBE INPUT MAY BE USED.

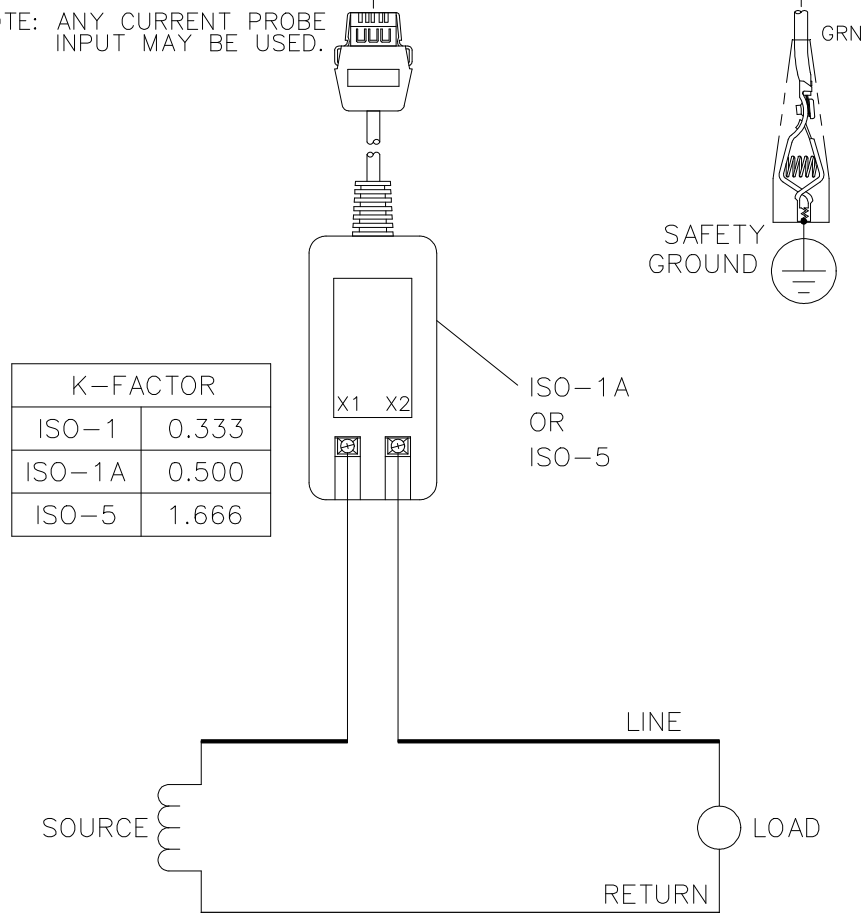

K-FACTOR	
ISO-1	0.333
ISO-1A	0.500
ISO-5	1.666

8600-25

*Continued on next page*

## Connecting to an Isolated Current Transformer (ISO), Continued

---

**Connecting to a non-Dranetz-BMI current probe**

The figure below shows the ISO box connected to a non-Dranetz-BMI clamp-on current transformer. In this case the scale factor is the product of the ISO box and the CT. Refer to manufacturer's literature to determine the CT scale factor.

---

**WARNING**

**Refer to the manufacturer's instructions related to the CT for exact information for connections for current monitoring. Do not exceed manufacturer's ratings.**

---

**ADVERTENCIA**

**Consulte las instrucciones del fabricante referentes a TC (transformador de corriente) para la información exacta de las conexiones a fin de monitorear la corriente. No exceda las capacidades nominales del fabricante.**

---

**ADVERTISSEMENT**

**Se reporter aux instructions du fabricant relatives au transformateur de courant (Current Transformer - CT) pour obtenir les renseignements exacts sur les connexions utilisées pour la surveillance du courant. Ne pas dépasser la puissance recommandée par le fabricant.**

---

**WARNUNG**

**Genaue Informationen zu Verbindungen für die Stromüberwachung entnehmen Sie bitte den Anleitungen des Herstellers (siehe Stromumwandler). Die Grenzwerte des Herstellers sollten nicht überschritten werden.**

---

*Continued on next page*

# Connecting to an Isolated Current Transformer (ISO), Continued

## Diagram

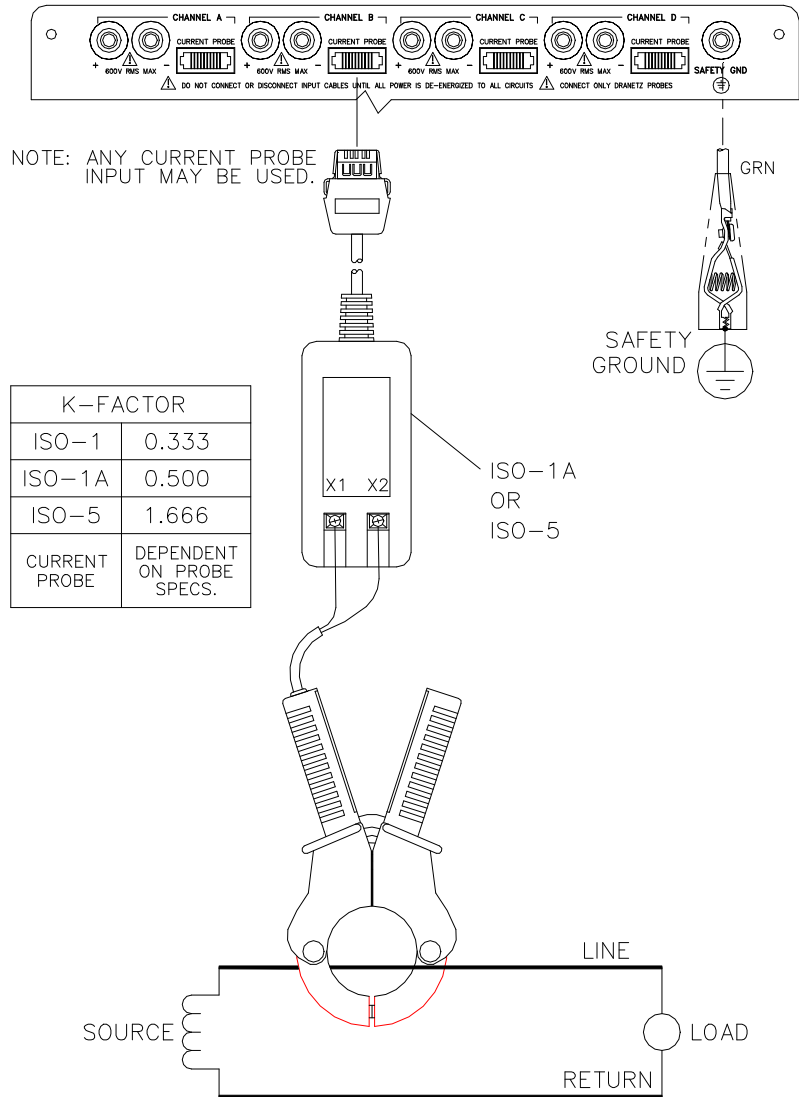

8600-26

## Section C

### Connection Diagrams

#### Overview

---

**Voltage and current connections**

This section contains numerous drawings of both voltage and current probe connections that are required when connecting the PP1 to the circuit to be tested. Follow these diagram carefully when making power measurements to ensure that ABC totals are calculated correctly.

Voltage: Voltage probes are connected to the individual source or load line and are referenced to the return (common) line voltage probe connection for greatest accuracy.

Current: Current probes are connected to each line and positioned to measure currents with reference to the voltage probe. Incorrectly positioned current probes may produce erroneous power measurement.

---

**Safety precautions**

Follow the safety precautions listed on page 3-12 when making all voltage probe connections.

---

**Medidas de seguridad**

Siga las medidas de seguridad listadas en la página 3-13 cuando efectúe todas las conexiones potenciales del transformador.

---

**Mesures de sécurité**

Suivez les mesures de sécurité données en page 3-13 lors de la réalisation de toutes les connexions du transformateur de tension.

---

**Sicherheitsvorkehrungen**

Folgen Sie den auf Seite 3-14 aufgeführten Sicherheitsvorkehrungen , wenn Sie an potentiellen Trafo-Verbindungen arbeiten.

---

*Continued on next page*

## Overview, Continued

---

**In this section** The following power connection diagrams are shown in this section.

<b>Diagram</b>	<b>See Page</b>
Single Phase	3-36
Split Phase	3-37
Four Wire Wye	3-38
Floating Delta	3-39
Delta, One Leg Grounded	3-40
Open Leg Delta	3-41
High-Leg Delta	3-42

---

# Single Phase

## Introduction

When making voltage connections to a single phase circuit use channel A differential inputs as shown below. Connect both terminals of channels B, C, and D together to prevent erroneous data. Channels D should be turned off if not used.

## Note

Be sure to connect the current probe with the arrow on the handle pointing towards the load or an erroneous power reading will result.

## Diagram

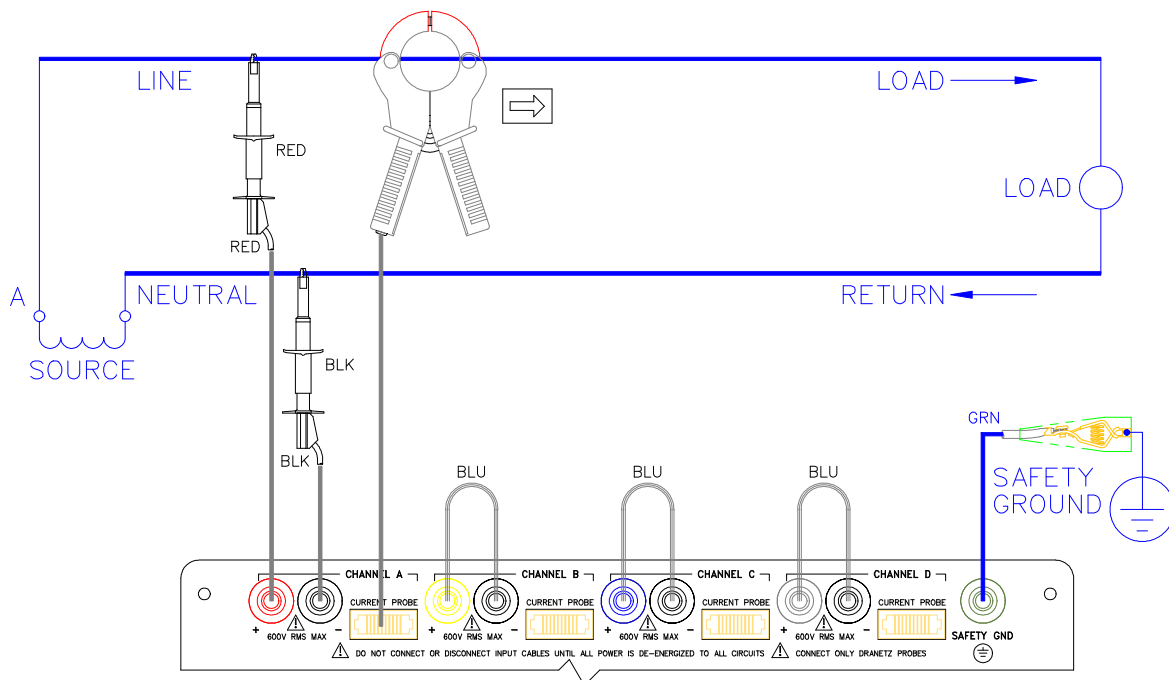

8600-6



# Split Phase

## Introduction

When making split phase measurements use both channels A and B for voltage and current connections. Connect both terminals of Channels C and D together to prevent erroneous data. The neutral is chosen as the reference for measurement purposes.

## Diagram

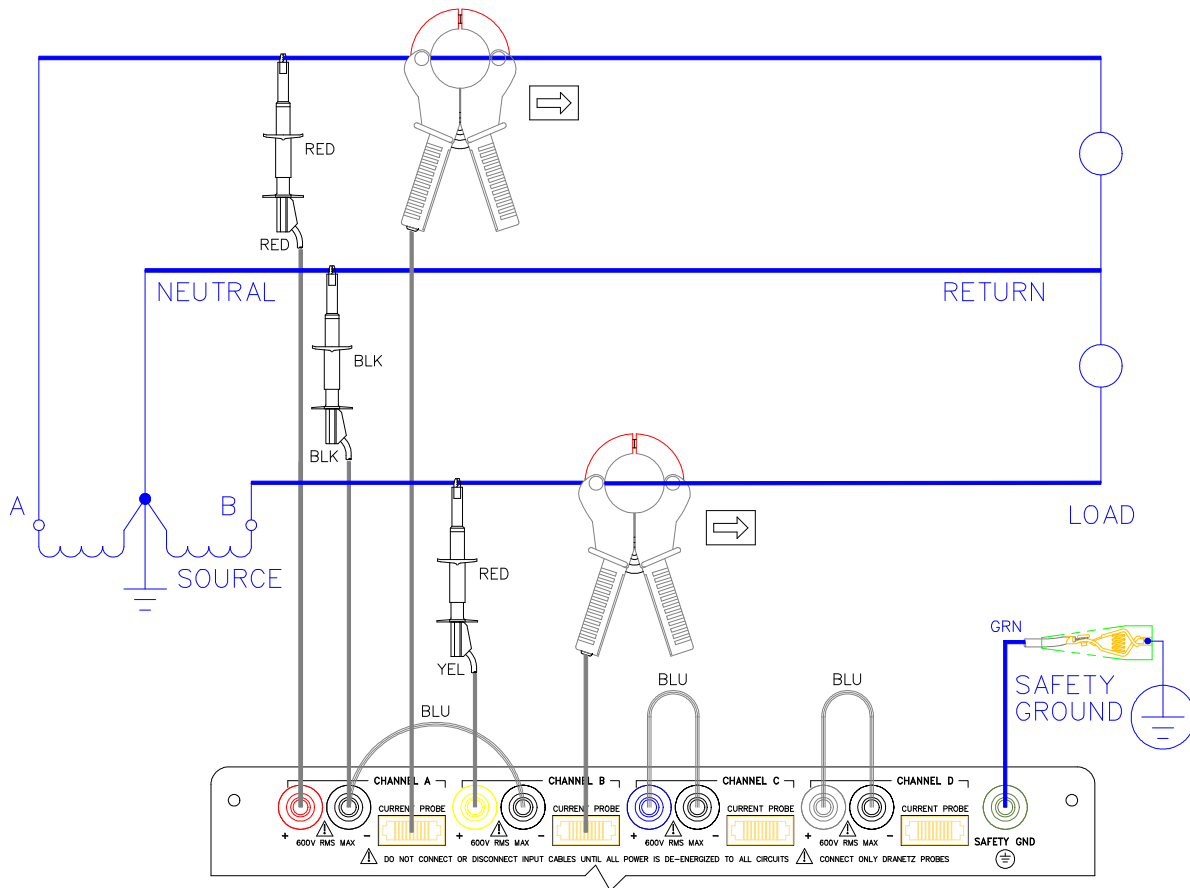

8600-7

# Four Wire Wye

## Introduction

Channels A, B, and C are connected to voltage and current probes. The neutral is connected to common and is the reference for the three channels. Connect both terminals of Channel D together to prevent erroneous data.

## Diagram

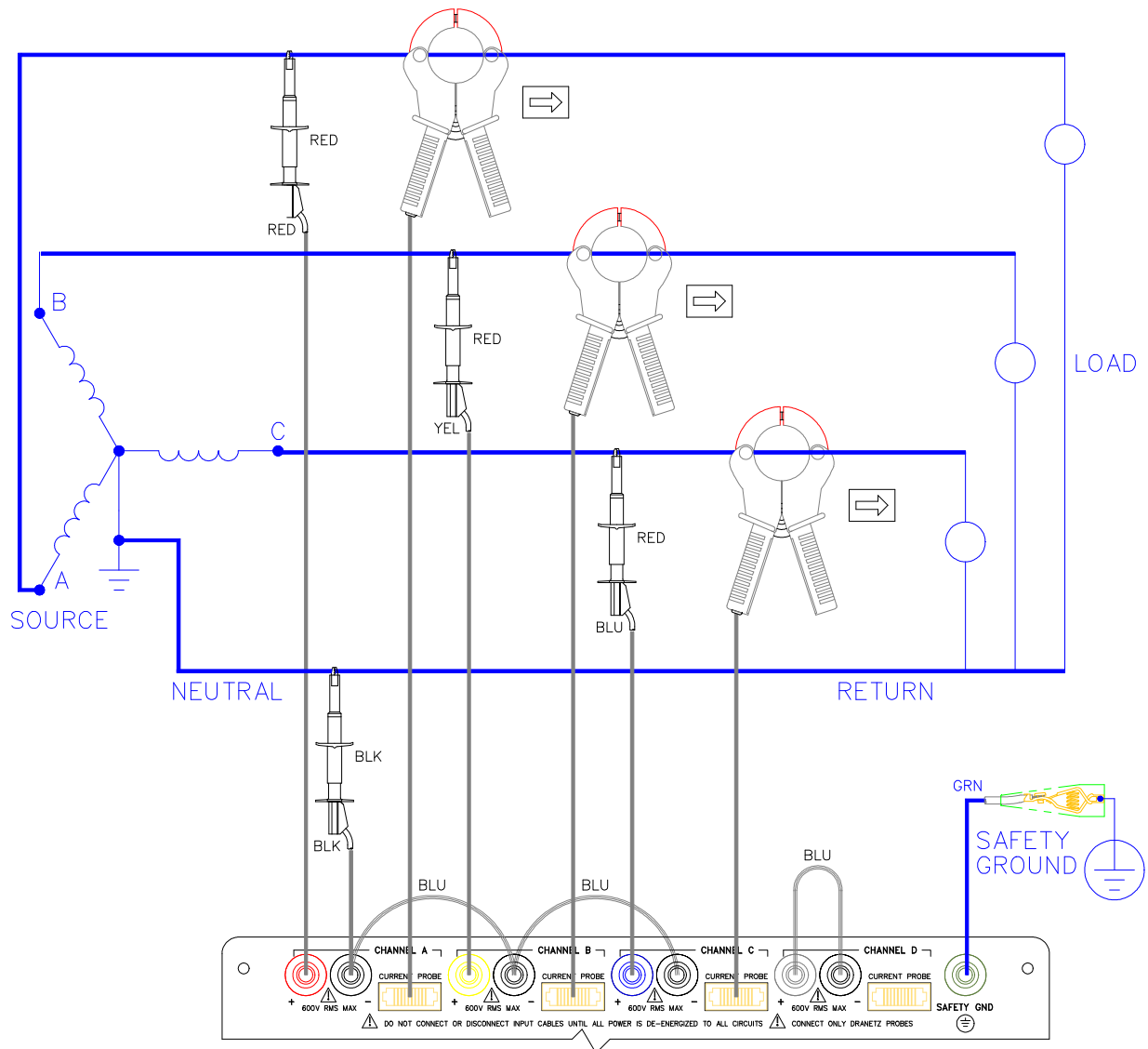

8600-12

# Floating Delta

## Introduction

In this power connection, the PP1-Inrush uses voltage channels A, B, and C as differential inputs with channel A using source voltage A-B, channel B using B-C, and channel C using C-A as the reference. Current probes are connected to channels A, B, and C. Connect both terminals of Channel D together to prevent erroneous data.

## Diagram

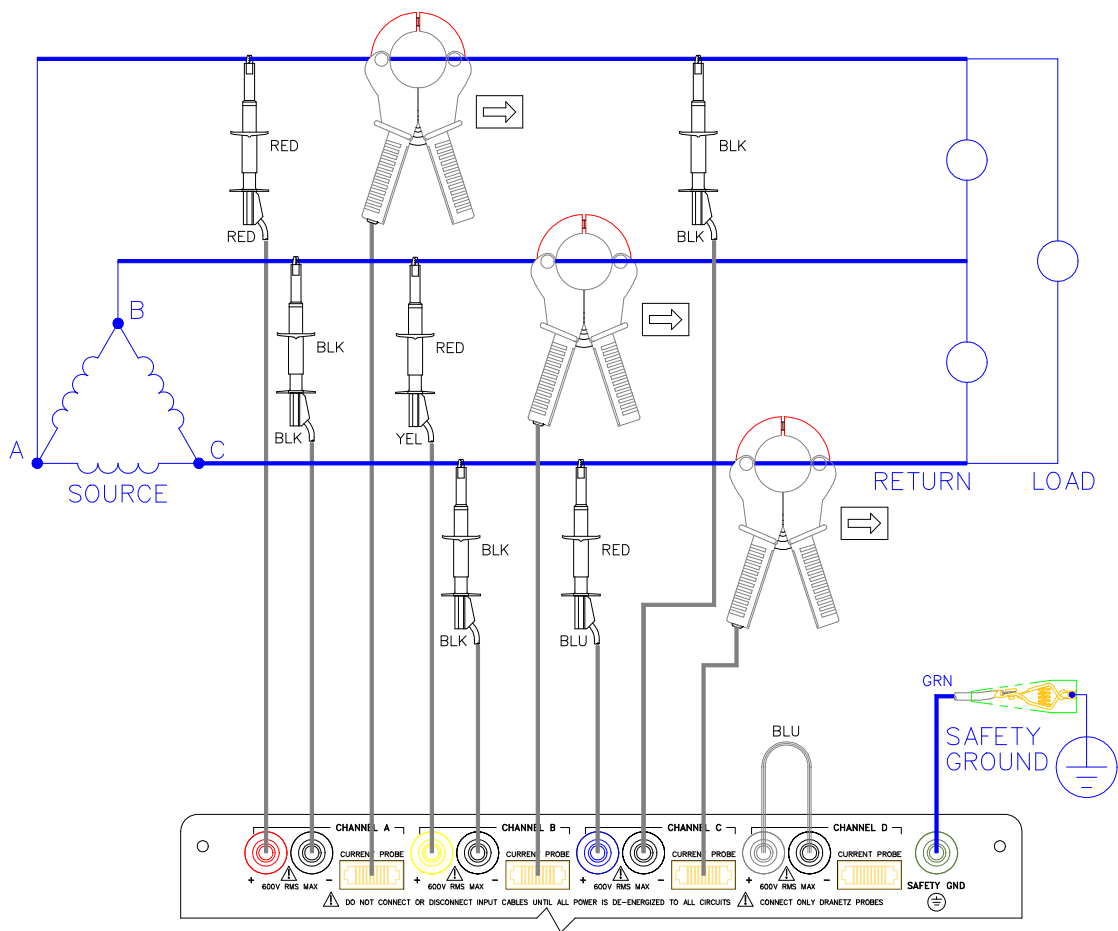

8600-9

# Delta, One Leg Grounded

## Introduction

In this power connection, the PP1-Inrush uses voltage channels A, B, and C as differential inputs with channel A using source voltage A-B, channel B using B-C, and channel C using C-A as the reference. Current probes are connected to channels A, B, and C. Connect both terminals of Channel D together to prevent erroneous data.

## Diagram

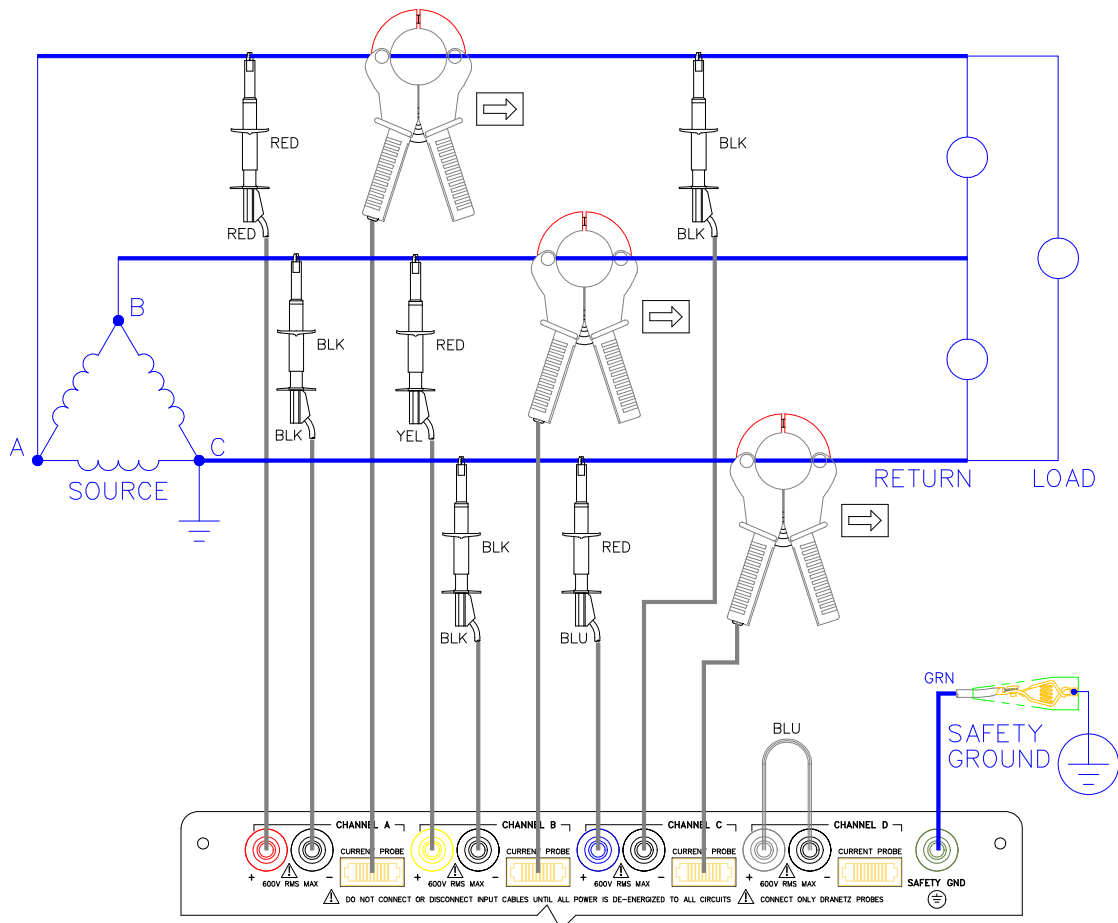

8600-8

# Open Leg Delta

## Introduction

The figure below shows the open leg delta with phase A-C connected to channel A and phase B-C connected to channel B. A jumper connects the A- and B-terminal. Current probes are connected to channels A and B.

## Diagram

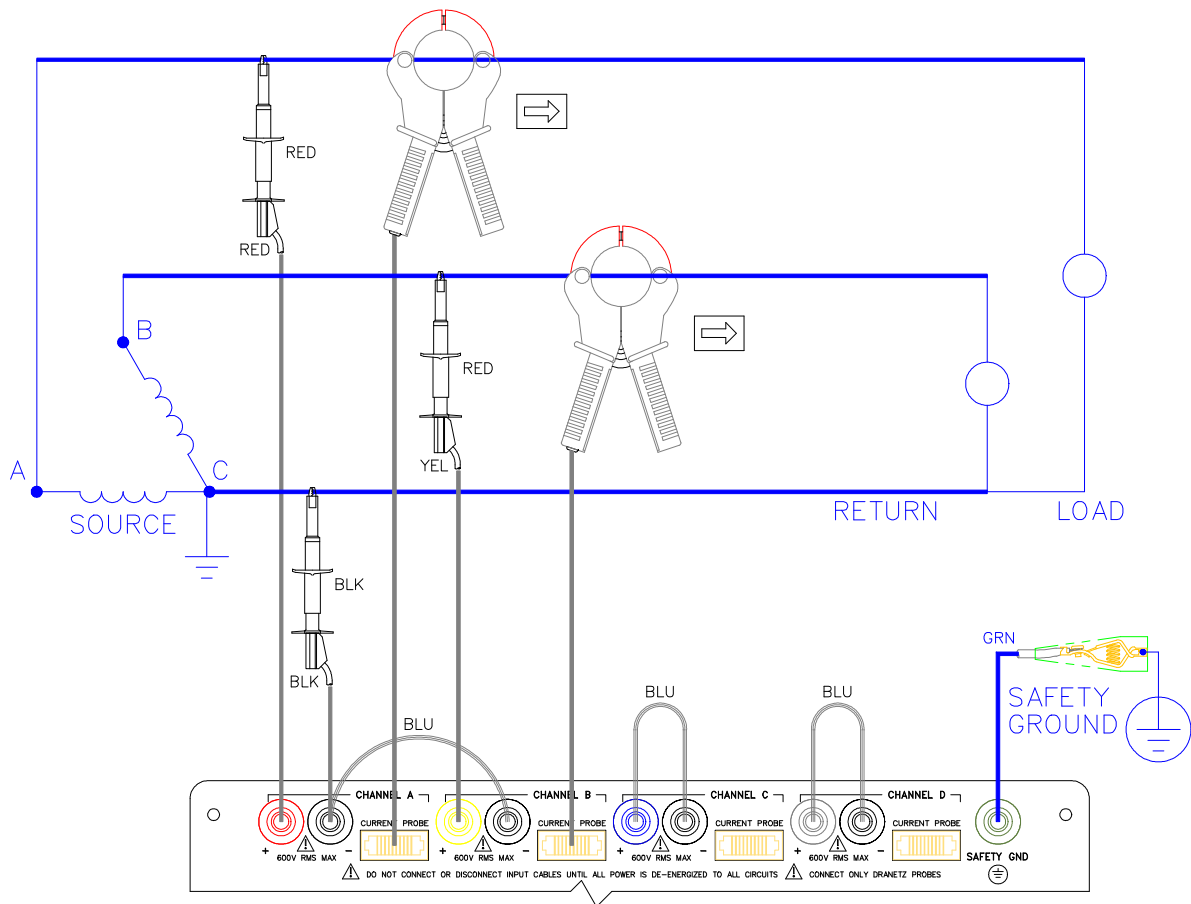

8600-10

# High-Leg Delta

## Introduction

The 4-wire delta connected 120/240V source shown in the figure on the next page is connected with one phase connected to ground at mid-point. This phase provides 120V at phases A and C to ground. Phase B is designated the high-leg connection and is measured at 208V ( $120V \times 1.73 = 208V$ ) to ground. The National Electrical Code (NEC 215-8) identifies the high-leg phase as the Orange colored line.

## Diagram

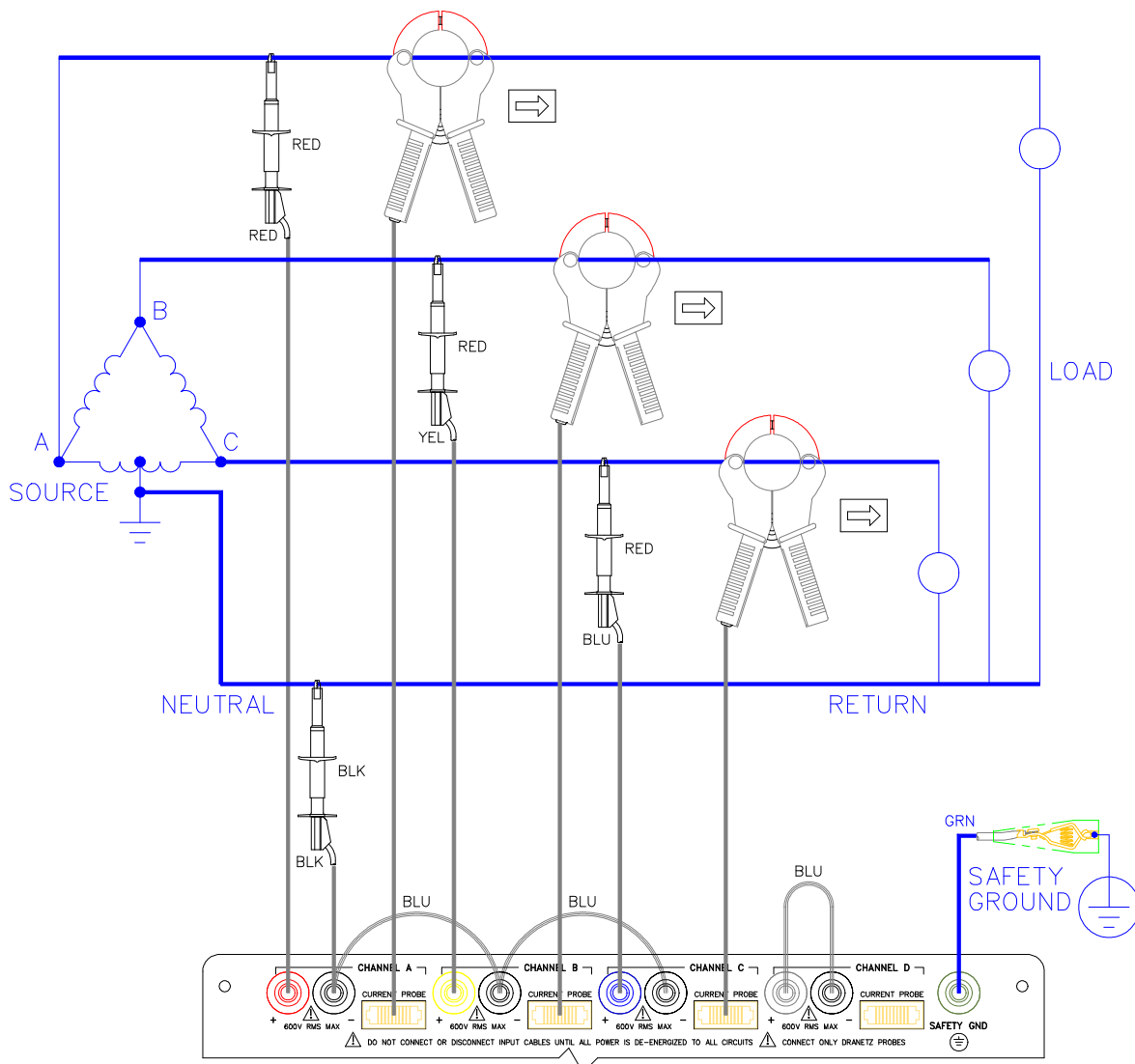

8600-11

# Phasor Diagrams for Standard Power Connections

**Diagrams** The following diagrams describe the voltage and current phasors (for resistive loads) for the standard type of power connections when selected for viewing in meter mode. The page number for the related power connection diagram is given in the left column. Refer to Chapter 3, Section D, for information about viewing voltage and current phasors.

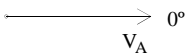
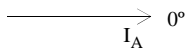
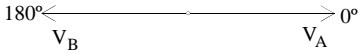
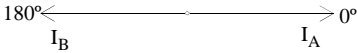
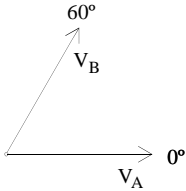
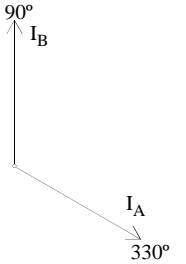
Power Connection Diagram	Voltage Phasor	Current Phasor
<p>Single Phase (See page 3-36)</p>		
<p>Split Phase (See page 3-37)</p>		
<p>Delta, One Leg Grounded (See page 3-40)</p>		

*Continued on next page*

# Phasor Diagrams for Standard Power Connections, Continued

Diagrams  
(continued)

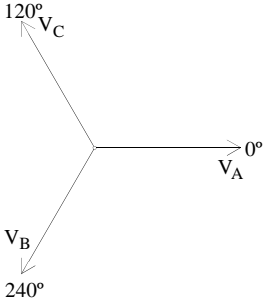
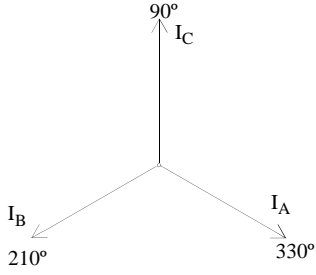
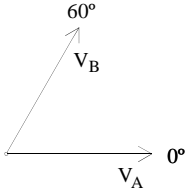
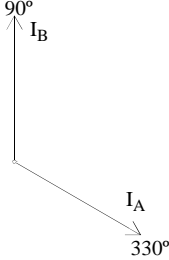
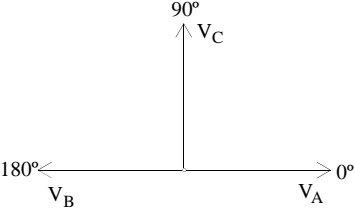
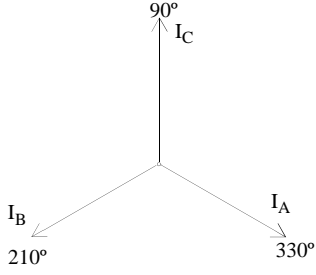
Power Connection Diagram	Voltage Phasor	Current Phasor
<p>Floating Delta (See page 3-39)</p>	 <p>120° <math>V_C</math> 0° <math>V_A</math> 240° <math>V_B</math></p>	 <p>90° <math>I_C</math> 210° <math>I_B</math> 330° <math>I_A</math></p>
<p>Open Leg Delta (See page 3-41)</p>	 <p>60° <math>V_B</math> 0° <math>V_A</math></p>	 <p>90° <math>I_B</math> 330° <math>I_A</math></p>
<p>High Leg Delta (See page 3-42)</p>	 <p>90° <math>V_C</math> 180° <math>V_B</math> 0° <math>V_A</math></p>	 <p>90° <math>I_C</math> 210° <math>I_B</math> 330° <math>I_A</math></p>

*Continued on next page*



# Phasor Diagrams for Standard Power Connections, Continued

**Diagrams**  
(continued)

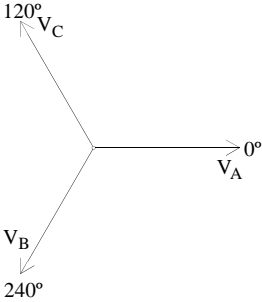
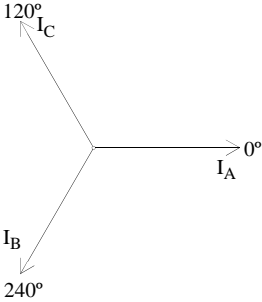
Power Connection Diagram	Voltage Phasor	Current Phasor
<p style="text-align: center;">Four Wire Wye (See page 3-38)</p>		

## Section D

### Scope and Meter Mode

#### Overview

---

**Introduction** This section describes the operation of scope and meter mode, which allows you to view real-time parameter data.

---

**In this section** The following topics are covered in this section.

Topic	See Page
Viewing Scope Mode	3-47
Viewing Meter Mode, Continued	3-50
Viewing Voltage and Current Phasors	3-52
Viewing Voltage and Current Harmonics	3-53

---

# Viewing Scope Mode

**Introduction** Scope Mode allows you to view the present voltage and current waveforms for up to four channels.

**Displaying the screen** Follow these steps to display the Scope Mode screen.

Step	Action
1	From Main Menu, select item 1, Meter Mode.
2	From the Meter Mode Menu, select item 6, Scope Mode.  <u>Result:</u> The following screen is displayed.

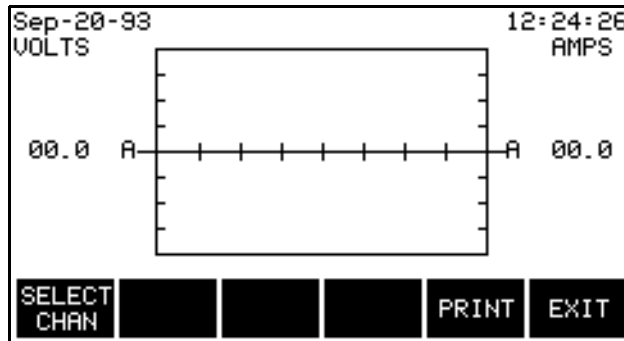

**Screen description** Waveform labels: Voltage waveforms are labeled on the left at the point where they cross the vertical axis. Current waveforms are labeled on the right at the point where they cross the vertical axis.

When more than one waveform crosses the vertical axis at the same point (same phase angle), the channel identifier for the waveform with the highest amplitude is placed first, and the lower values follow below. If the amplitudes are also identical then the A-B-C order is used.

Vertical scale: Scaled relative to the waveform with the largest peak value. Voltage and current are scaled separately.

Horizontal scale: Scaled to display one cycle. Each tick mark is 45 degrees.

Update rate: The display is updated approximately once every two seconds.

*Continued on next page*

## Viewing Scope Mode, Continued

### How to select channels for display

Follow these steps to select channels for the Scope Mode display.

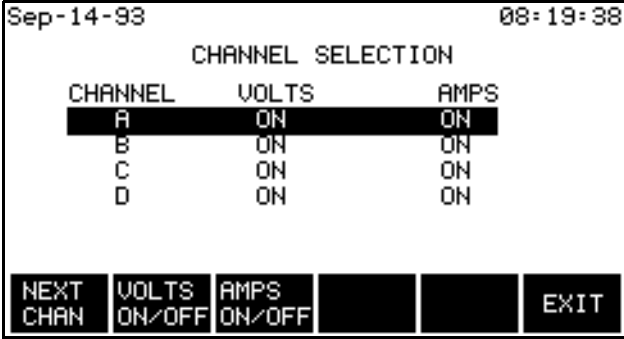
Step	Action
1	<p>In Scope Mode display, press SELECT CHAN. The Channel Selection screen is displayed as shown below.</p> <p><u>Result:</u> The following screen will appear.</p>  <pre> Sep-14-93                                08:19:38                                 CHANNEL SELECTION CHANNEL    VOLTS    AMPS ----- A          ON      ON B          ON      ON C          ON      ON D          ON      ON  NEXT CHAN  VOLTS  AMPS            ON/OFF ON/OFF EXIT           </pre>
2	Press VOLTS ON/OFF to toggle selected channel On or Off for voltage waveform display.
3	Press AMPS ON/OFF to toggle selected channel On or Off for current waveform display.
4	Press NEXT CHAN to select channels A, B, C, and/or D as shown below.
5	Repeat steps 2 through 4 for each channel to be selected.
6	Press EXIT to display the channels selected.

## Viewing Meter Mode

---

### Types of displays

You can select any one channel for viewing with all parameters displayed, or you can select an individual parameter for viewing with all channels displayed.

---

### Channels that can be viewed

Channels A, B, C, or D can be viewed individually or collectively for single phase monitoring. For Delta mode the sequence is: A-B, B-C, C-A, D, and ABC.

---

### Available parameters

The following table lists the parameters that can be viewed in meter mode.

Parameter	Symbol	Group
Volts RMS	V	1
Amps RMS	I	1
Watts	W	1
Volt-amps	VA	1
Volt-amps Reactive	VAR	2
Power Factor (True)	PF	2
Voltage Frequency	Hz	2
Voltage Unbalance	Vunb%	2
Volts, Total Harmonic Distortion	Vthd	3
Amps, Total Harmonic Distortion	Ithd	3
Current Crest Factor	Icf	3
k-Factor	KF	3

---

*Continued on next page*

## Viewing Meter Mode, Continued

**Procedure** Follow these steps to view the meter mode displays.

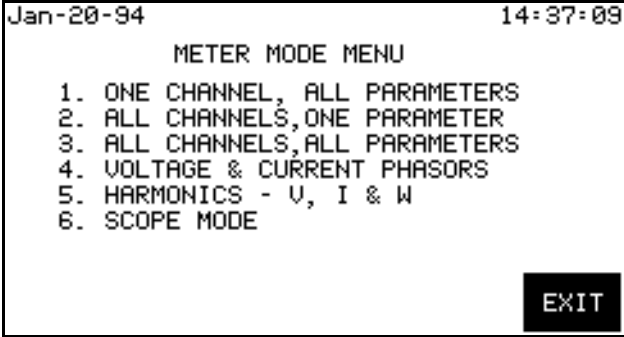
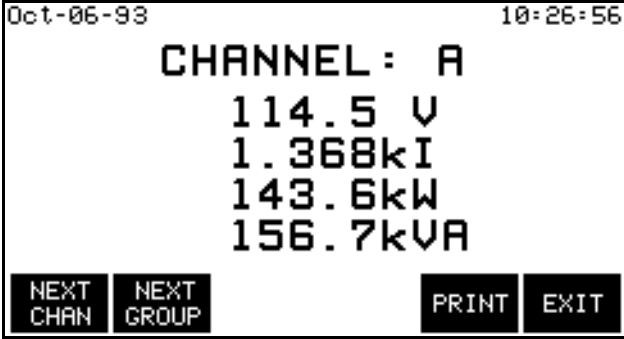
Step	Action
1	<p>From Main Menu, select item 1, Meter Mode Menu.</p> <p><u>Result:</u> The following screen appears.</p> 
2	<p>Press 1 if one channel and all parameters are to be viewed.</p>  <p>Press NEXT CHAN to display next channel parameters. Press NEXT GROUP to display the next group of data for the channel selected.</p>

*Continued on next page*

## Viewing Meter Mode, Continued

**Procedure**  
(continued)

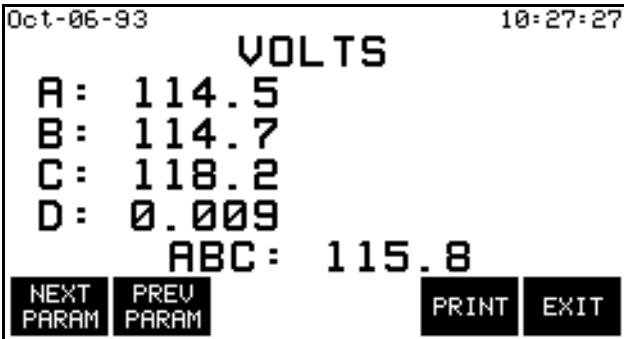
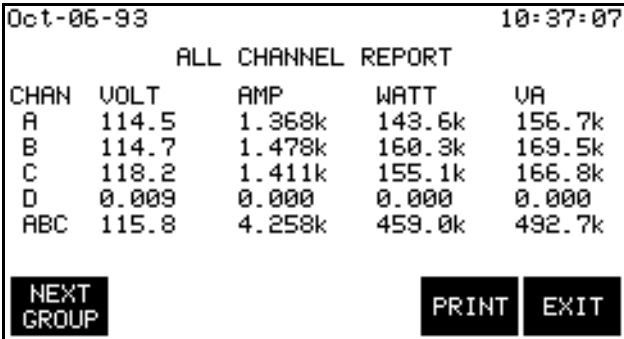
Step	Action
3	<p>Press 2 if all channels and one parameter are to be viewed.</p>  <pre> Oct-06-93                               10:27:27                                 VOLTS A:  114.5 B:  114.7 C:  118.2 D:   0.009       ABC: 115.8 NEXT  PREV  PRINT  EXIT PARAM PARAM           </pre>
4	<p>Press 3 for the all channels, all parameters display.</p>  <pre> Oct-06-93                               10:37:07                                 ALL CHANNEL REPORT CHAN  VOLT    AMP      WATT    VA A     114.5   1.368k  143.6k  156.7k B     114.7   1.478k  160.3k  169.5k C     118.2   1.411k  155.1k  166.8k D     0.009   0.000   0.000   0.000 ABC   115.8   4.258k  459.0k  492.7k NEXT  PRINT  EXIT GROUP           </pre>

# Viewing Voltage and Current Phasors

**Procedure** Follow these steps to view the current and voltage phasors displays.

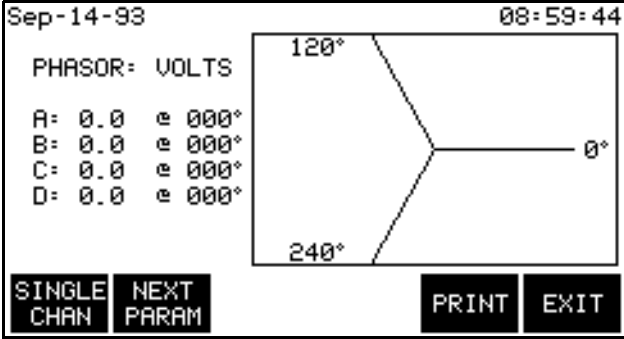
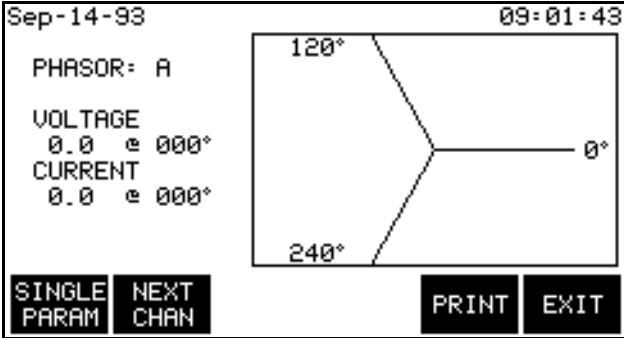
Step	Action
1	From Main Menu, select item 1, Meter Mode.
2	<p>From Meter Mode menu press 4, Voltage &amp; Current Phasors.</p> <p><u>Result:</u> The following screen will appear if no inputs are connected.</p> 
3	<p>Press SINGLE CHAN to display the Single Channel Phasors display.</p> 

**Display symbols** Phasor vectors are displayed clockwise from the zero degrees reference. Dependent on the phases being monitored, up to four channels may be displayed at any one time for either volts or amps, or a single channel for both volts and amps. An arrow head and channel label are displayed on the vector arm.



# Viewing Voltage and Current Harmonics

**Screen description**

Viewing the voltage and current harmonics permits you to display harmonics in the form of a graph or a table.

Graph: The graph displays the magnitude of each harmonic as a percentage of the fundamental, rms, or maximum load current. The left edge of the graph represents the fundamental frequency.

Table: The table lists the magnitude and phase for each harmonic. This screen displays harmonic's magnitude and phase relative to fundamental, rms, or maximum load current of the channel and parameter selected.

Update rate: All displays are updated once every five seconds.

Harmonics displayed: The number of harmonics displayed is up to the 50th for 60Hz and up to the 8th for 400Hz. When viewing inrush data the number of harmonics displayed is also related to the Samples/Cycle setting on the Set Inrush Trigger screen. Refer to page 6-3 for details.

**Displaying the graph screen**

Follow these steps to view the harmonics graph display.

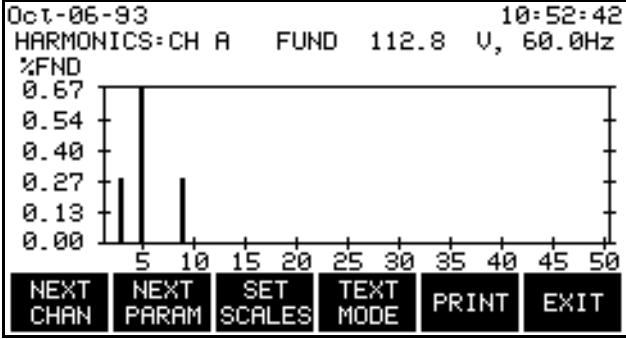
Step	Action
1	From Main Menu select 1, Meter Mode.
2	From Meter Mode select 5, Voltage and Current Harmonics.  <u>Result</u> : A screen similar to the following will appear.    For the table display of this graph, see page 3-55.

*Continued on next page*

## Viewing Voltage and Current Harmonics, Continued



### Changing the channel and parameter

Use the following keys to change the channels and/or parameter displayed.

- NEXT CHAN to select channels A, B, C, or D.
- NEXT PARAM for selection of V, A, or W.

### Changing the vertical scale

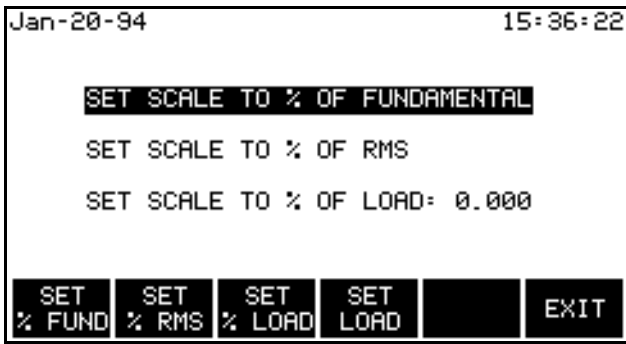
Follow these steps to change the vertical scale of the harmonic graph display.

Step	Action
1	<p>Press SET SCALES.</p> <p><u>Result:</u> The following screen is displayed.</p>  <p><u>Note:</u> Scale based on following values and conventions:</p> <ul style="list-style-type: none"> <li>•% of Fund - THD, North American convention</li> <li>•% of rms - THD, IEC 555-2, European convention</li> <li>•% of load - TDD, IEEE 519 recommendation</li> </ul>
2	<p>Press one of the SET% keys.</p> <ul style="list-style-type: none"> <li>• If you pressed SET% FUND or SET% RMS, go to step 5.</li> <li>• If you pressed SET% LOAD go to step 3.</li> </ul>
3	<p>Press SET LOAD</p> <p><u>Result:</u> The menu bar changes to the following.</p> 
4	Enter the value for maximum load current.
5	Press EXIT to return to harmonics graph.

*Continued on next page*

## Viewing Voltage and Current Harmonics, Continued

**Viewing the text display** To view the harmonics text display, press the TEXT MODE key from the graph display.

**Result:** A screen similar to the following will appear.

```

Oct-06-93                               10:53:24
HARMONICS=CH A   FUND  112.8  V, 60.0Hz
H#  MAG%  PHS  H#  MAG%  PHS  H#  MAG%  PHS
02  0.000  000  09  0.288  000  16  0.000  000
03  0.288  180  10  0.000  000  17  0.000  000
04  0.000  000  11  0.000  000  18  0.000  000
05  0.672  000  12  0.000  000  19  0.000  000
06  0.000  000  13  0.000  000  20  0.000  000
07  0.000  000  14  0.000  000  21  0.000  000
08  0.000  000  15  0.000  000  22  0.000  000
NEXT  NEXT  NEXT  GRAPH  PRINT  EXIT
CHAN  PARAM SET  MODE
  
```

**Note** For the watts parameter only, harmonic power direction is indicated by a sign in front of the MAG% (watts magnitude) value. A minus sign (-) indicates that the harmonic power flows in the opposite direction of the source-load arrow on the CT. No sign indicates that the harmonic power flows in the same direction as the source-load arrow on the CT.

A load is indicated if the CT arrow is pointing at the physical load and there is no sign on the watts magnitude. This is the normal situation. If the sign on the watts magnitude is negative, then the load is actually a source (generator).

A negative sign on the fundamental watts usually indicates that the CT is on backwards, or the arrow is pointing in the wrong direction.

**Function keys** The following table provides a description of the functions keys for the harmonics text screen.

Key	Function
NEXT CHAN	Displays the next channel of data.
NEXT PARAM	Displays the next parameter of data: V, A, or W.
NEXT SET	Displays the next set of harmonics: 02 to 22, 23 to 43, 44 to 50th harmonics for 60 Hz.
GRAPH MODE	Returns to the harmonics graph screen.
PRINT	Prints the screen.



# Chapter 4

## Housekeeping Functions

### Overview

---

**Introduction** Housekeeping functions consists of the miscellaneous tasks that you need to perform to keep your PP1-Inrush running in an efficient and organized way. These are tasks that you might perform only occasionally.

---

**In this chapter** The following topics are covered in this chapter.

Topic	See Page
Entering or Editing a Site Name	4-2
Setting the Time and Date	4-4
Selecting the Language	4-6
Setting the Audible Alarm and LCD Mode	4-7
Running a Self-Test	4-8

---

# Entering or Editing a Site Name

**Introduction** This function allows you to enter or edit a site name of up to 20 characters. The site name appears on printouts and is also used for file names on the memory card.

**Procedure** Follow these steps to enter a site name.

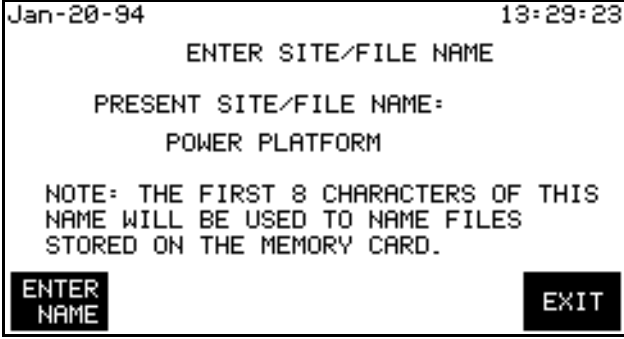
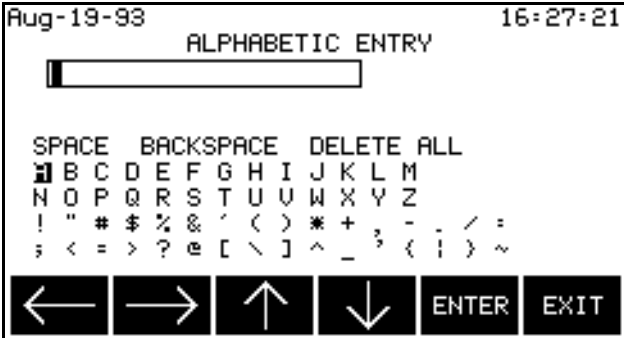
Step	Action
1	Select item 5, Set Analyzer Parameters, from the Main Menu.
2	<p>Select item 1, Set Site/File Name, from the Set Analyzer Parameters Menu.</p> <p><u>Result:</u> The following screen will appear.</p> 
3	<p>Press the ENTER NAME key.</p> <p><u>Result:</u> The following screen will appear.</p> 

*Continued on next page*

## Entering or Editing a Site Name, Continued

---

**Procedure**  
(continued)

<b>Step</b>	<b>Action</b>
4	Highlight a desired letter or symbol using the arrow keys.
5	Press ENTER.  <u>Note:</u> Enter numbers from the keypad.
6	Repeat steps 5 and 6 until the entire name has been entered.
7	Use the Backspace command to move the highlight to the left.

---

# Setting the Time and Date

## Displaying the screen

Follow these steps to display the time and date screen.

Step	Action
1	Select item 5, Set Analyzer Parameters, from the Main Menu.
2	Select item 2, Set Time and Date, from the Set Analyzer Parameters Menu.  <u>Result:</u> The following screen will appear.

```

Sep-14-93                                09:26:25
      SET TIME AND DATE
PRESENT TIME (hh:mm:ss) : 09:26:24
PRESENT DATE (mmm-dd-yy): Sep-14-93

ENTER TIME  ENTER DATE                    EXIT
    
```

## Setting the time

Follow these steps to set the time.

Step	Action						
1	Press the ENTER TIME key.  The menu bar changes to the following.						
	<div style="border: 1px solid black; padding: 5px; display: inline-block;"> <table border="1" style="border-collapse: collapse;"> <tr> <td style="padding: 2px 10px;">ENTER</td> <td style="padding: 2px 10px;">BACK SPACE</td> <td style="width: 30px;"></td> <td style="width: 30px;"></td> <td style="width: 30px;"></td> <td style="padding: 2px 10px;">EXIT</td> </tr> </table> </div>	ENTER	BACK SPACE				EXIT
ENTER	BACK SPACE				EXIT		
2	Enter the hours, minutes, and seconds, pressing the ENTER key after each number.						

*Continued on next page*



## Setting the Time and Date, Continued

---

**Setting the date** Follow these steps to set the date.

Step	Action
1	<p>Press the ENTER DATE key.</p> <p>The menu bar changes to the following.</p> <div data-bbox="675 600 1297 667" style="text-align: center;"><pre>ENTER   BACK SPACE               EXIT</pre></div>
2	<p>Enter the number of the month.</p> <p><u>Example</u>: Enter 1 for January, 2 for February, etc.</p>
3	<p>Press ENTER.</p>
4	<p>Enter the day and the year, pressing the ENTER key after each.</p>

---

## Selecting the Language

---

**Note**

English is the only available language for version 1.0.

---

## Setting the Audible Alarm and LCD Mode

### Displaying the screen

Follow these steps to display the Other Devices screen.

Step	Action
1	From the Main Menu, select item 5, Set Analyzer Parameters.
2	From the Set Analyzer Parameters Menu, select item 4, Configure Other Devices.  <u>Result:</u> The following screen will appear.

```

Jan-20-94                               13:37:35
      OTHER DEVICES CONFIGURATION
LCD BACKLIGHT AUTO-SHUTOFF: ENABLED
PRINTER ON/OFF: ON
PRINTER BATTERY OPERATION: TIME LIMIT
AUDIBLE ALARM ON/OFF: ON
LCD DISPLAY MODE: NORMAL
      (press 1 to change)
BACK  PRINTR PRINTR ALARM  PRINT  EXIT
LIGHT ON/OFF BATTERY ON/OFF
    
```

### LCD backlight auto-shutoff

Enabled: The backlight for the LCD display will shut off if no key has been pressed for 15 minutes.

Disabled: The backlight for the LCD display will stay on continuously.

Note: The auto-shutoff feature extends the life of the backlight and is recommended for use.

### Audible alarm

Press the ALARM ON/OFF to toggle the alarm on and off.

### LCD mode

Normal mode: Displays text and graphics as blue on a white background.

Invert mode: Displays text and graphics as white on a blue background.

### Note

See Chapter 9 for printer functions.

# Running a Self-Test

---

**Introduction** The self-test function performs an extensive test of the system. The test lasts approximately 45 seconds. Only run the self-test during non-critical monitoring times, as no data is acquired during the test.

---

**CAUTION** **Monitoring will be turned off for the duration of the test.**

---

**PRECAUCIÓN** **El monitoreo quedará apagado mientras dure la prueba.**

---

**MISE EN GARDE** **La surveillance sera mise à l'arrêt pour toute la durée du test.**

---

**VORSICHT** **Die Überwachung ist während des Tests ausgeschaltet.**

---

**Procedure** Follow these steps to run a self-test.

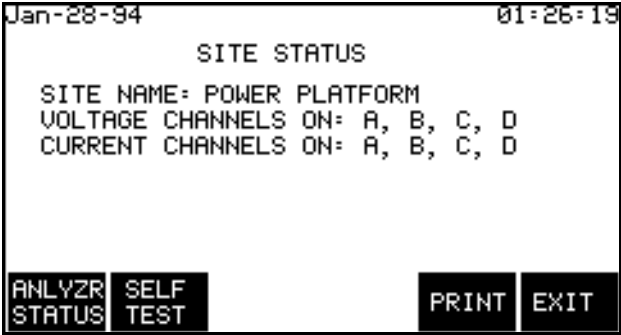
Step	Action
1	From the Main Menu, select item 7, Status.   <p>The screenshot shows a terminal window with the following text: 'Jan-28-94' at the top left, '01:26:19' at the top right, 'SITE STATUS' in the center, 'SITE NAME: POWER PLATFORM', 'VOLTAGE CHANNELS ON: A, B, C, D', and 'CURRENT CHANNELS ON: A, B, C, D'. At the bottom, there are four menu options: 'ANLYZR', 'SELF', 'STATUS', and 'TEST' on the left, and 'PRINT' and 'EXIT' on the right.</p>

*Continued on next page*

## Running a Self-Test, Continued

**Procedure**  
(continued)

Step	Action
2	Press SELF TEST to display the following message. <div data-bbox="675 478 1295 814" style="border: 1px solid black; padding: 5px; margin: 10px auto; width: fit-content;"> <pre> Aug-18-93                               15:47:03       RUN SELF-TEST CAUTION: SELF TEST HAS BEEN SELECTED. THE ANALYZER SHUTS DOWN NORMAL DATA ACQUISITION AND ANALYSIS DURING THIS TIME. MISREPRESENTATION OF DATA MAY RESULT.  * PRESS 'BEGIN TEST' TO CONTINUE. * PRESS 'EXIT' TO ABORT.  BEGIN TEST                               EXIT           </pre> </div>
3	Press BEGIN TEST. The following screen is displayed. <div data-bbox="675 932 1295 1268" style="border: 1px solid black; padding: 5px; margin: 10px auto; width: fit-content;"> <pre> Aug-18-93                               15:49:39        RUNNING SELF-TEST       PLEASE WAIT...  EXIT           </pre> </div>

At the completion of the test, the analyzer status screen is displayed.

```

Jan-20-94                               13:24:29
      ANALYZER STATUS DISPLAY
PRINTER: ON                               BATTERY: GOOD
MEMORY: 1024k GOOD                       INPUT: GOOD
HOST CPU: V 1.0 GOOD
I/O CPU: V 1.0 GOOD
ACP CPU: V 1.0 GOOD

PRINT EXIT
          
```



# Chapter 5

## Input Channels Setup

### Overview

---

**Introduction** This chapter contains the procedures you need to perform after you have connected the unit to the circuit that you want to test. Once you have made all voltage and current connections, you have to set up the unit so that it knows what inputs you are using and what kind of circuit you are measuring.

---

**In this chapter** This chapter covers the following topics:

Topic	See Page
Turning Input Channels On and Off	5-2
Selecting Your Circuit Type	5-4
About Scale Factors	5-6
Entering Scale Factors	5-7
About Frequency Synchronization	5-9
Selecting Sync Frequency	5-11

---

# Turning Input Channels On and Off

**Introduction** You must turn on any input channel that will be used for monitoring. If a channel is not turned on, no data will be collected for it.

**Definition** Input channels are the four voltage and current channels on the rear panel labelled A, B, C, and D.

**Displaying the screen** Follow these steps to display the Input Channel Configuration screen.

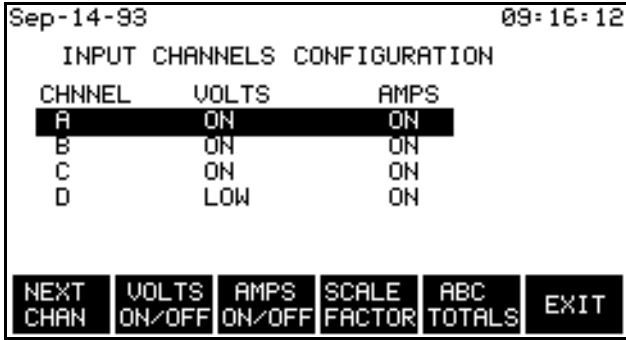
Step	Action
1	From the Main Menu, select item 2, Set Trigger.
2	Press INPUT CONFIG.  <u>Result:</u> The following screen will appear.  

*Continued on next page*



## Turning Input Channels On and Off, Continued

**Procedure** Follow these steps to turn on any or all input channels.

<b>Step</b>	<b>Action</b>
1	Press the VOLTS ON/OFF key to toggle the highlighted voltage channel between on and off.  <u>Note:</u> Channel D voltage has three possible settings: LOW, HIGH, and OFF. Pressing this key cycles through the three settings.
2	Press the AMPS ON/OFF key to toggle the highlighted current channel between on and off.
3	Press the NEXT CHAN key.
4	Repeat steps 1 to 3 for each channel.
5	Press EXIT.  <u>Result:</u> The Set Inrush Trigger Type screen appears and the Maximum Duration value will be updated.

**Where to go from here**

Refer to the following table to find the next topic.

<b>IF you want to...</b>	<b>THEN see page</b>
select your circuit type (ABC TOTALS)	5-4
enter scale factors	5-6
select sync frequency	5-9

# Selecting Your Circuit Type

**Introduction** You must select a circuit type when you are collecting data for power parameters such as watts, VA's, and VAR's. If you don't select the proper circuit type, the ABC totals won't be calculated correctly.

**Displaying the screen** Follow these steps to display the Wiring Configuration and Scale Factors screen.

Step	Action
1	Select item 2, Set Trigger, from the Main Menu.
2	Press INPUT CONFIG.
3	Press the ABC TOTALS key.  <u>Result:</u> The following screen will appear.

```
Jan-27-94 09:51:48
WIRING CONFIGURATION & SCALE FACTORS
CONFIG. FOR ABC TOTALS: SINGLE PHASE
SCALE FACTOR: CHN  VOLTS  AMPS
                A   1.0000  1.0000
                B   1.0000  1.0000
                C   1.0000  1.0000
                LOW D   1.0000  1.0000
FREQ SYNC (Press 1 to change): EXTERNAL

ABC  NEXT  ENTER  ENTER  PRINT  EXIT
CONFIG CHAN  SCALE  FREQ
```

*Continued on next page*

## Selecting Your Circuit Type, Continued

**Procedure** Follow these steps to select your circuit type.

Step	Action																
1	Determine the circuit type that the Power Platform is connected to according to the diagrams in Chapter 3, Section C.																
2	Press the ABC CONFIG key until the correct ABC config. is displayed according to the following table: <table border="1" data-bbox="607 590 1349 1010"> <thead> <tr> <th>IF the Power Platform is connected to this circuit type...</th> <th>THEN select this ABC config...</th> </tr> </thead> <tbody> <tr> <td>Single Phase</td> <td>Single Phase</td> </tr> <tr> <td>Split Phase</td> <td>Split Phase</td> </tr> <tr> <td>Four Wire Wye</td> <td>3 Phase Wye</td> </tr> <tr> <td>Floating Delta</td> <td>3 Phase Delta</td> </tr> <tr> <td>Delta, One Leg Grounded</td> <td>3 Phase Delta</td> </tr> <tr> <td>Open Leg Delta</td> <td>Split Phase</td> </tr> <tr> <td>High-Leg Delta</td> <td>3 Phase Wye</td> </tr> </tbody> </table>	IF the Power Platform is connected to this circuit type...	THEN select this ABC config...	Single Phase	Single Phase	Split Phase	Split Phase	Four Wire Wye	3 Phase Wye	Floating Delta	3 Phase Delta	Delta, One Leg Grounded	3 Phase Delta	Open Leg Delta	Split Phase	High-Leg Delta	3 Phase Wye
IF the Power Platform is connected to this circuit type...	THEN select this ABC config...																
Single Phase	Single Phase																
Split Phase	Split Phase																
Four Wire Wye	3 Phase Wye																
Floating Delta	3 Phase Delta																
Delta, One Leg Grounded	3 Phase Delta																
Open Leg Delta	Split Phase																
High-Leg Delta	3 Phase Wye																
3	Press the EXIT key.																

**Where to go from here**

Refer to the following table to find the next topic.

IF you want to...	THEN see page
enter scale factors	5-6
select sync frequency	5-9

## About Scale Factors

---

### What are scale factors?

Scale factors are the ratio of input to output for a particular current transformer (CT) or potential transformer (PT). Scale factors are entered into the PP1-Inrush and then multiplied automatically by the measured voltage and current so that the unit displays the correct values.

Note: If voltage and current connections are made without using any of the above named devices, the scale factor should be set to 1.

---

### When to use

Scale factors other than 1 must be entered for the following conditions.

- A Dranetz-BMI current probe is connected to a permanently installed CT.
  - The current connections are made using an ISO box.
  - The voltage connections are made using a PT.
- 

### Dranetz-BMI equipment

Current Probes: All Dranetz-BMI current probes have a scale factor of 1.

ISO-1: 0.333

ISO-1A: 0.500

ISO-5: 1.666

---

### Non-Dranetz-BMI equipment

Refer to the CT name plate or to the manufacturers literature to determine the scale factor.

---

### What to enter

Single device: The scale factor for a single CT or PT is calculated from its step-up or step-down ratio.

Example: A potential transformer has a step-down ratio of 1000:5, therefore:  
Scale Factor =  $1000/5 = 200$

Multiple devices: Multiply the scale factors of all devices.

Example: A CT with a scale factor of 200 is connected to a Dranetz-BMI ISO-5.  
Scale Factor =  $200 \times 1.666 = 333$

---

# Entering Scale Factors

**Range** 0.001 to 999,900

**Displaying the screen** Follow these steps to display the Wiring Configuration and Scale Factors screen.

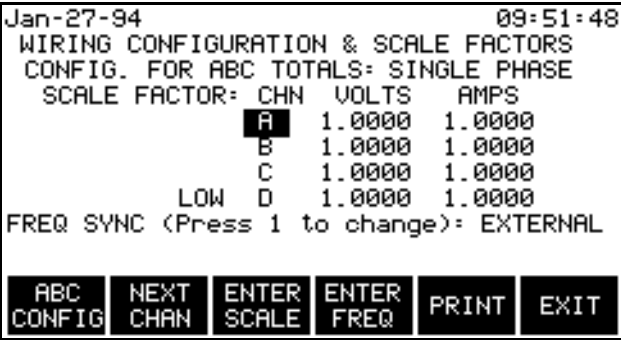
Step	Action
1	From the Main Men, select item 2, Set Trigger.
2	Press INPUT CONFIG.
3	<p>Press the SCALE FACTOR key.</p> <p><u>Result:</u> The following screen will appear.</p>  <pre> Jan-27-94                                09:51:48 WIRING CONFIGURATION &amp; SCALE FACTORS CONFIG. FOR ABC TOTALS: SINGLE PHASE SCALE FACTOR: CHN  VOLTS  AMPS                    A  1.0000  1.0000                    B  1.0000  1.0000                    C  1.0000  1.0000                    LOW D 1.0000  1.0000 FREQ SYNC (Press 1 to change): EXTERNAL  ABC CONFIG  NEXT CHAN  ENTER SCALE  ENTER FREQ  PRINT  EXIT     </pre>

*Continued on next page*

## Entering Scale Factors, Continued

**Procedure** Follow these step to enter scale factors.

Step	Action
1	Press the ENTER SCALE key.  The menu bar will change to the following.  
2	Enter the scale factor for the voltage channel.
3	Press ENTER.
4	Enter the scale factor for the current channel.
5	Press ENTER.
6	Press NEXT CHAN.
7	Repeat steps 2 to 7 for each channel that needs scale factors.
8	Press EXIT.

# About Frequency Synchronization

---

## Frequency sync modes

The PP1 has three modes of frequency synchronization (sync): external, internal, and channel D.

External: When set to external, frequency synchronization of PP1-Inrush analog signal processing circuits is controlled by sampling the external AC signal input on channel A. Loss of external sync causes the PP1-Inrush to sample other valid voltage channels for an alternate external sync. If none exists, then internal sync is automatically selected.

Internal: When set to internal, frequency synchronization of PP1-Inrush analog signal processing circuits is controlled by the frequency that is displayed on the Wiring Configuration and Scale Factors screen.

Channel D: When set to Channel D, frequency synchronization of PP1-Inrush analog signal processing circuits is controlled by sampling the external AC signal input on channel D only. If a valid sync signal does not exist on channel D then internal sync is automatically selected.

Improper sync setup will result in erroneous data being collected and displayed.

---

## Sync during power-up

On power-up, the PP1-Inrush will initially attempt to sync on channel A input voltage phase unless set to internal or channel D. If a valid input is available, then the PP1-Inrush will sync in the external mode and will remain in this mode until the sync level is lost.

If channel A sync cannot be acquired, then the next valid voltage channel will be polled to re-initiate external sync in accordance with the following wiring configuration.

Wiring Configuration	Valid Voltage Channel for Sync
Single Phase	A, D
Split Phase	A, B, D
3 Phase Delta	A, B, C, D
3 Phase Wye	A, B, C, D

---

*Continued on next page*

## About Frequency Synchronization, Continued

---

**Loss of external sync during power up** If external sync cannot be acquired on any valid channel, then the PP1-Inrush will revert to internal sync. The frequency used for internal is entered on the Wiring Configuration screen. Refer to page 5-11 for the procedure.

The valid voltage channels will be polled in the background in an attempt to reacquire external sync.

When no external sync signal is found, an error message is displayed (and printed) to inform you of this condition.

---

**Loss of sync during collection of inrush data** If sync is lost during collection of inrush data, the PP1-Inrush will switch to internal sync without any delay.

The internal sync in this condition will be the last frequency measured before sync was lost. The internal sync frequency entered in the wiring configuration screen (see next page) will not be used unless you change over to internal sync.

---



# Selecting Sync Frequency

## Introduction

Selection of the sync frequency is fixed to the input voltage monitoring frequency in external and channel D sync mode and to a frequency selected by the operator in the internal sync mode. The default sync frequency is the external sync. You can select any of the sync modes.

## Procedure

Follow these steps select an internal or external sync.

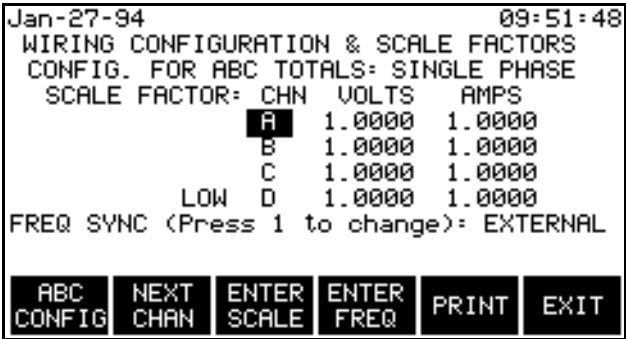
Step	Action
1	From the Main Menu, select item 2, Set Trigger.
2	Press INPUT CONFIG.
3	Press SCALE FACTOR from the Input Channel Configuration screen.  The following screen appears when External sync is the default sync frequency.  

*Continued on next page*

## Selecting Sync Frequency, Continued

**Procedure**  
(continued)

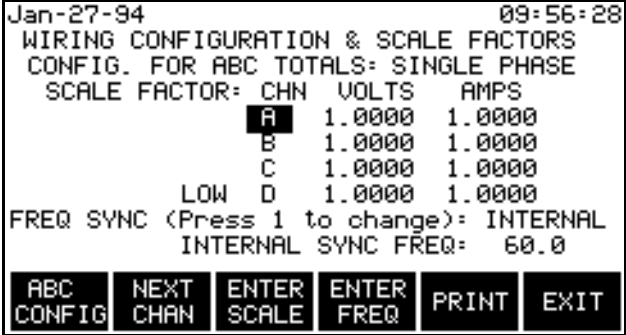
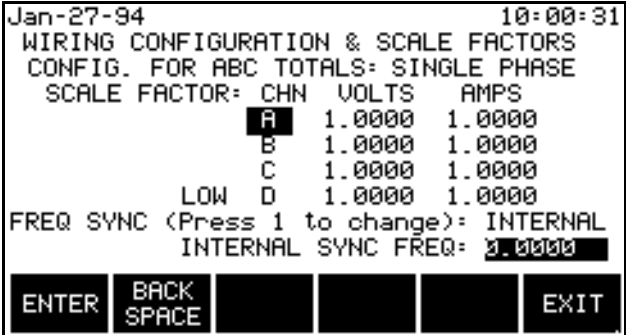
Step	Action
4	<p>Press number 1 from the keyboard. The following screen appears to display the Internal sync mode.</p>  <pre> Jan-27-94                                09:56:28 WIRING CONFIGURATION &amp; SCALE FACTORS CONFIG. FOR ABC TOTALS: SINGLE PHASE SCALE FACTOR: CHN  VOLTS  AMPS                 A   1.0000 1.0000                 B   1.0000 1.0000                 C   1.0000 1.0000                 LOW D   1.0000 1.0000 FREQ SYNC (Press 1 to change): INTERNAL INTERNAL SYNC FREQ: 60.0 ABC  NEXT  ENTER  ENTER  PRINT  EXIT CONFIG CHAN SCALE  FREQ </pre>
5	<p>To change the Internal Sync Frequency press ENTER FREQ. The following screen appears.</p>  <pre> Jan-27-94                                10:00:31 WIRING CONFIGURATION &amp; SCALE FACTORS CONFIG. FOR ABC TOTALS: SINGLE PHASE SCALE FACTOR: CHN  VOLTS  AMPS                 A   1.0000 1.0000                 B   1.0000 1.0000                 C   1.0000 1.0000                 LOW D   1.0000 1.0000 FREQ SYNC (Press 1 to change): INTERNAL INTERNAL SYNC FREQ: 1.0000 ENTER  BACK  [ ]  [ ]  [ ]  EXIT SPACE </pre>
6	Enter the internal frequency desired using format XX.XX.
7	Press ENTER to re-display the screen of step 5 to verify selection.
9	Press number 1 again to change the frequency sync to Channel D.
10	To return to External sync, press number 1 at the keyboard. The display of step 3 will return.

# Chapter 6

## Inrush Trigger Setup

### Overview

---

**What is a trigger setup?** A trigger setup is a group of operator selected conditions that controls the initiation and collection of inrush data. Data collection begins when the trigger condition is met and continues for a preselected length of time. There are three triggering methods available: manual, rms, and external; only one of which can be active at a time.

---

**CAUTION** The external sync mode should be used when collecting inrush data. If the internal sync mode is used, fluctuations in frequency could result in erroneous data. Before setting the trigger, verify that the frequency sync mode is set to External or Channel D on the Wiring Configuration screen. Refer to page 5-11.

---

**PRECAUCIÓN** Se debe usar el modo de sincronización externa cuando recoja datos inrush. Si se utiliza el modo de sincronización externa, las fluctuaciones en la frecuencia podrían producir datos erróneos. Antes de fijar el disparador, verifique si se ha ajustado el modo de sincronización de frecuencia a Externa o Canal D en la pantalla Configuración de cableado. Consulte la página 5-11.

---

**MISE EN GARDE** Le mode de synchronisation externe devrait être utilisé lors de la collecte de données d'appel. Si vous utilisez le mode de synchronisation interne, des fluctuations de fréquence pourraient produire des données erronées. Avant de régler le mécanisme de déclenchement, assurez-vous que le mode de synchronisation de fréquence est sur External ou Channel D sur l'écran de Wiring Configuration. Reportez-vous à la page 5-11.

---

**VORSICHT** Bei der Sammlung von Inrush-Daten sollte der externe Sync-Modus benutzt werden. Wenn der interne Sync-Modus benutzt wird, können Fluktationen in der Frequenz in fehlerhafte Daten resultieren. Bevor Sie den Trigger einstellen, Stellen Sie sicher, daß der Frequenz-Sync-Modus auf Extern oder Kanal D auf dem Verdrahtungskonfigurationsbildschirm eingestellt ist. Lesen Sie dazu Seite 5-11.

---

*Continued on next page*

## Overview, Continued

---

**In this chapter** The following topics are covered in this chapter.

<b>Topic</b>	<b>See Page</b>
Set Inrush Trigger Type Screen	6-3
Setting Trigger Parameters	6-6
Manual Trigger	6-8
RMS Trigger	6-9
External Trigger	6-12
Data Collection and Processing	6-16

---

## Set Inrush Trigger Type Screen

---

### Screen description

The Set Inrush Trigger Type screen displays the type of trigger selected, the number of pre-trigger cycles that will be recorded, the percentage of samples per cycle that will be recorded, the recording duration, and the maximum duration possible. These recording duration values are presented in seconds per channel and cycles per channel. Each additional channel that is selected will reduce the recording duration. See page 6-5 for the table of recording durations for different screen settings.

---

### Displaying the screen

From the Main Menu, select item 2 Set Trigger.

Result: The following screen will appear.

```
Jun-30-94                               11:10:23
      SET INRUSH TRIGGER TYPE
TRIGGER ON =MANUAL
PRE-TRIGGER CYCLES:  1 CYCLES/CHANNEL
SAMPLES PER CYCLE: 100%
RECORDING DURATION=  8.13 SECONDS/CHAN
                   368  CYCLES/CHAN

MAXIMUM DURATION=   8.13 SECONDS/CHAN
                   368  CYCLES/CHAN

SELECT TRIG INPUT  MORE  EXIT
TRIG  SETUP CONFIG
```

### Screen settings

Trigger On: Displays the trigger type: manual, rms, or external.

Pre-Trigger: Displays the number of cycles/channel that will be saved before the trigger condition is met. This number can't exceed the maximum recording duration minus 10 cycles.

---

*Continued on next page*

## Set Inrush Trigger Type Screen, Continued

---

**Screen settings**  
(continued)

Samples Per Cycle: Displays the currently selected percentage: 100%, 50%, or 25%. This setting will allow you to collect more data by decreasing the number of samples/cycle that the PP1 collects, but will also affect the number of harmonics that can be displayed on the harmonics screen when viewing saved inrush data. The following table lists the number of harmonics that can be viewed depending upon the frequency being monitored and the percentage selected.

Samples/Cycle	Number of Harmonics Displayed	
	22-68 Hz	360-544 Hz
100%	50	8
50%	32	4
25%	16	2

The lower settings will also affect the accuracy of rms calculations.

Recording Duration: Displays the current setting for the amount of data that will be recorded for each active channel. The recording duration includes the pre- and post-trigger cycles and is limited to the maximum duration shown on the display. The maximum duration values of seconds/chan and cycles/chan are directly dependent on the number of recording channels selected and the samples/cycle setting. Refer to page 5-2 for information about changing the number of recording channels.

---

**Note**

In the 400 Hz mode, the seconds/chan field is 1/8 of the true value shown for the recording and maximum durations.

---

*Continued on next page*

## Set Inrush Trigger Type Screen, Continued

---

**Screen settings**  
(continued)

Maximum Recording Duration: Displays the maximum possible amount of data that can be recorded for each active channel. The following table lists the maximum recording duration possible based on the number of channels turned ON at 60 Hz.

Number of Channels	Maximum Recording Duration	
	sec/chan*	cycles/chan*
1	49.12	2947
2	24.55	1473
3	16.37	982
4	12.27	736
5	9.82	589
6	8.18	491
7	7.02	421
8	6.13	368

\*Multiply by 2 for 50% setting and by 4 for 25% setting.

---



# Setting Trigger Parameters

## Introduction

The following parameters are common to all trigger types: pre-trigger cycles, samples/cycle, and recording duration

## Set number of pre-trigger cycles

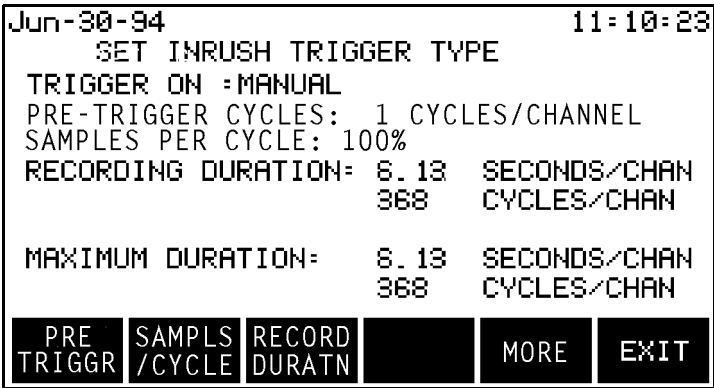
Follow these steps to change the number of pre-trigger cycles.

Step	Action
1	<p>From the Set Inrush Trigger Type screen, press MORE.</p> <p><u>Result:</u> The following screen will appear.</p> 
2	<p>Press PRE TRIGGER.</p> <p><u>Result:</u> The menu bar will change to the following.</p> 
3	Enter a number from 1 to 10.
4	Press ENTER

## Set samples/cycle

Press SAMPLS/CYCLE until the desired percentage is displayed.

*Continued on next page*



## Setting Trigger Parameters, Continued

### Set recording duration

Follow these steps to change the recording duration.

Step	Action
1	Press RECORD DURAT.  <u>Result:</u> The menu bar will change to the following.  
2	Enter the number of seconds that you want to record data for.
3	Press ENTER.

### Select trigger type

Press SELECT TRIG until the desired trigger type is displayed.

Refer to the following table for the next procedure.

IF you selected...	THEN see page...
Manual	6-8
RMS	6-9
External	6-12

### CAUTION

**Changing any trigger parameter will delete all inrush data.**

### PRECAUCIÓN

**Si se cambia cualquier parámetro del disparador borrará todos los datos inrush.**

### MISE EN GARDE

**La modification d'un paramètre de déclenchement effacera les données d'appel.**

### VORSICHT

**Das Ändern jeglicher Trigger-Parameter wird alle Inrush-Daten löschen.**

# Manual Trigger

**Introduction** The manual trigger is selected by pressing the SELECT TRIG key on the Set Inrush Trigger Type screen.

**Procedure** Follow these steps to collect data using the manual trigger.

Step	Action
1	From the Set Inrush Trigger Type screen, press EXIT to display the Main Menu.
2	From the Main Menu, select item 3, Arm Trigger.  <u>Result:</u> The following screen will appear. 
3	Press START to initiate data collection, or EXIT to abort the process and return to the Main Menu.  <u>Note:</u> Circuit being tested must be turned on immediately after the START key is pressed or inrush data may be lost.
4	If data collection has started, go to page 6-16.

# RMS Trigger

**Introduction** The RMS trigger is selected by pressing the SELECT TRIG key on the Set Inrush Trigger Type screen.

The RMS trigger is activated by the RMS value of a voltage or current channel going above a specified maximum limit, or below a specified minimum limit. To prevent the Power Platform from triggering at one or the other limit a “don't care” value, designated by xxx, can be entered.

**Note** In the 400Hz mode, the rms trigger is calculated for eight cycles instead of one.

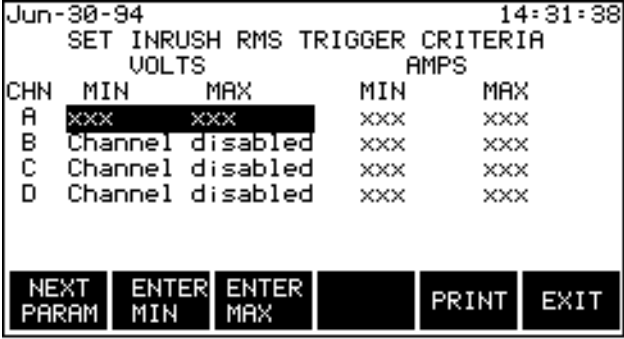

**Entering limit values** Follow these steps to enter limit values for the rms trigger.

Step	Action
1	<p>From the Set Inrush Trigger Type screen, press TRIG SETUP.</p> <p><u>Result:</u> The following screen appears.</p>  <pre> Jun-30-94 14:31:38 SET INRUSH RMS TRIGGER CRITERIA VOLTS AMPS CHN MIN MAX MIN MAX A xxx xxx xxx xxx B Channel disabled xxx xxx C Channel disabled xxx xxx D Channel disabled xxx xxx  NEXT PARAM ENTER MIN ENTER MAX PRINT EXIT           </pre> <p><u>Note:</u> “Channel disabled” is displayed for all channels turned OFF on the Input Channels Selection screen.</p>

*Continued on next page*

## RMS Trigger, Continued

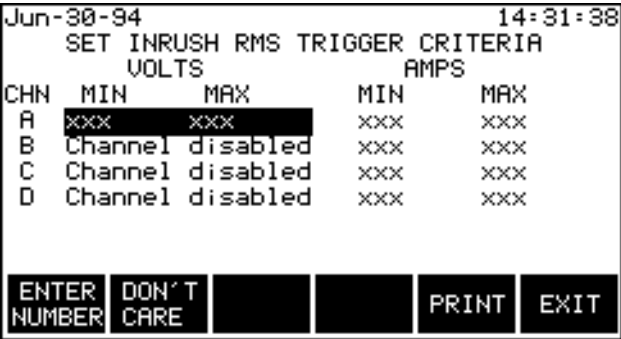
### Entering limit values (continued)

Step	Action
2	<p>Press ENTER MIN or ENTER MAX.</p> <p><u>Result:</u> The following screen appears</p> 
3	<p>If you want to enter a number for the limit, go to the next step, else press DON'T CARE and go to step 8.</p> <p><u>Note:</u> At least one Min or Max limit must be set or the PP1 will never trigger.</p>
4	<p>Press ENTER NUMBER.</p> <p><u>Result:</u> The menu bar will change to the following.</p> 
5	Enter a number for the limit.
6	Press ENTER.
7	Press EXIT.
8	Press EXIT.
9	Press NEXT PARAM until the desired limit is highlighted.
10	Repeat steps 2 thru 9 for each limit that you want to set.

*Continued on next page*

## RMS Trigger, Continued

**Arming trigger** Follow these steps to arm the RMS trigger.

Step	Action
1	<p>From the Main Menu, select item 3, Arm Trigger.</p> <p><u>Result:</u> The following screen will appear.</p> <div data-bbox="675 558 1295 892" style="border: 1px solid black; padding: 10px; text-align: center;"><p>ARM INRUSH TRIGGER <span style="float: right;">16:24:01</span></p><p>Waiting for RMS trigger. Audible alarm will sound when trigger conditions are met.</p><p>Press any key to abort.</p></div>
2	When alarm sounds, go to page 6-16.

# External Trigger

---

**Control Functions**

When External Trigger is selected on the Set Inrush Trigger Type screen, the digital inputs located on the rear panel can be used to control data collection in two ways: External Trigger and Start/stop.

---

**External trigger definition**

Function whereby an on signal received at digital input #3 or #4 causes data collection to start.

On signal: low to high transition on digital input #3 or #4.

---

**Start/stop definition**

Function whereby the unit starts collection data when a start signal is received at digital input #1 and continues to collect data until a stop signal is received at digital input #2, or until memory is full.

Start signal: low to high transition on digital input #1.

Stop signal: high to low transition on digital input #2.

---

**Note**

Either start/stop or external trigger can be active at one time.

---

**WARNING**

**Make all connections with the power off.**

---

**ADVERTENCIA**

**Haga todas las conexiones con la energía apagada.**

---

**ADVERTISSEMENT**

**Effectuez toutes les connexions avec l'alimentation coupée.**

---

**WARNUNG**

**Arbeiten Sie nur mit ausgeschaltetem Strom an allen Verbindungen.**

---

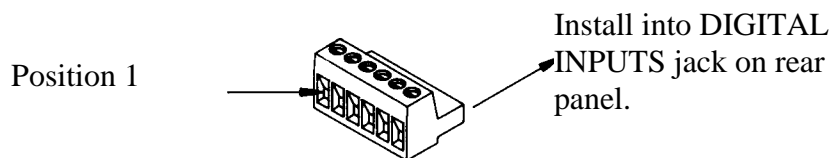
**Terminal block**

## External Trigger, Continued

Wire gauges #30 to #14 AWG

**External trigger connection diagram** Make external trigger connections to the rear panel according to the following diagram. Users must provide the external DC supply.

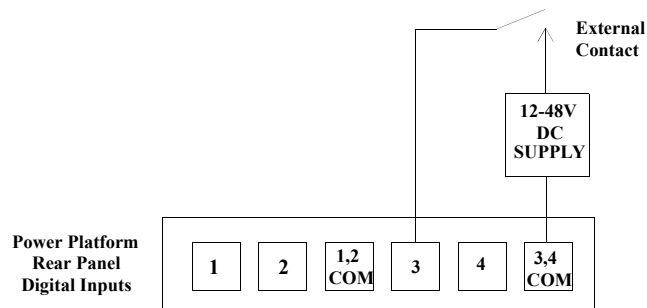

**Note** The inputs labeled 1,2 COM and 3,4 COM are not connected together internally. If the same power source is used to power contacts 1&2 and 3&4, then the commons must be connected together externally.

**Start/stop connection diagram** Make start/stop connections to the rear panel according to the following diagram. Users must provide the external DC supply.

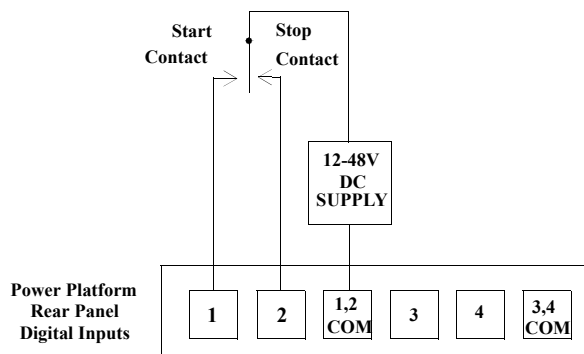

## External Trigger, Continued

### Connection procedure

Follow these steps when making connections to the digital inputs on the rear panel.

Step	Action
1	Insert a wire into the appropriate open position on the terminal block.
2	Tighten the screw clamp.
3	Repeat steps 1 and 2 for each wire you want to connect.
4	Push the terminal block into the digital input connector on the rear panel.

### Setting digital inputs configuration

Follow these steps to set the digital inputs configuration.

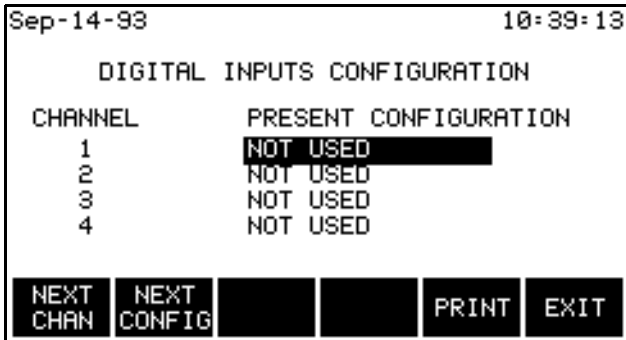
Step	Action
1	<p>From the Set Inrush Trigger Type screen, press TRIG SETUP.</p> <p><u>Result:</u> The following screen appears.</p>  <pre> Sep-14-93                               10:39:13           DIGITAL INPUTS CONFIGURATION CHANNEL      PRESENT CONFIGURATION   1          NOT USED   2          NOT USED   3          NOT USED   4          NOT USED NEXT CHAN  NEXT CONFIG  PRINT  EXIT           </pre> <p>If you are using external trigger mode, go to next step. If you are using start/stop mode go to step 4.</p>
2	Press NEXT CHAN until channel 3 or 4 is highlighted.
3	<p>Press NEXT CONFIG</p> <p><u>Result:</u> EXTERNAL TRIGGER will appear for the selected channel.</p> <p>Go to step 6.</p>

*Continued on next page*



## External Trigger, Continued

### Setting digital inputs configuration (continued)

Step	Action
4	Press NEXT CHAN until channel 1 or 2 is highlighted.
5	Press NEXT CONFIG  <u>Result:</u> START/STOP will appear for both Channel 1 and Channel 2.  Go to next step.
6	Press EXIT twice.
7	From the Main Menu, select item 3, Arm Trigger.  <u>Result:</u> The following screen will appear. <div data-bbox="675 858 1295 1192" style="border: 1px solid black; padding: 10px; margin: 10px auto; width: fit-content;"> <pre style="font-family: monospace; font-size: 0.8em;"> 16:23:17 ARM INRUSH TRIGGER  Waiting for a digital trigger. Audible alarm will sound when trigger conditions are met.  Press any key to abort. </pre> </div>
8	When alarm sounds, go to page 6-16.

# Data Collection and Processing

---

## Collection

The following screen will be displayed while the PP1 is collecting data.

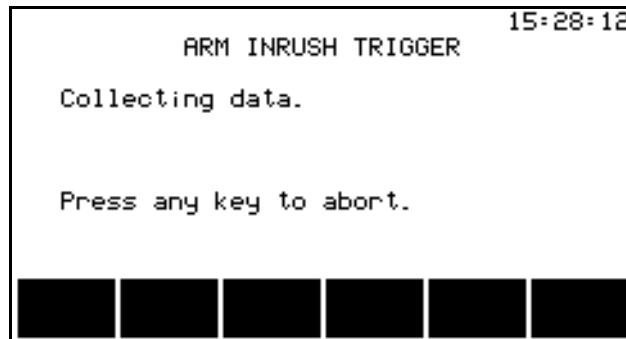

---

## Processing

The following screen is displayed while the PP1 is processing data.

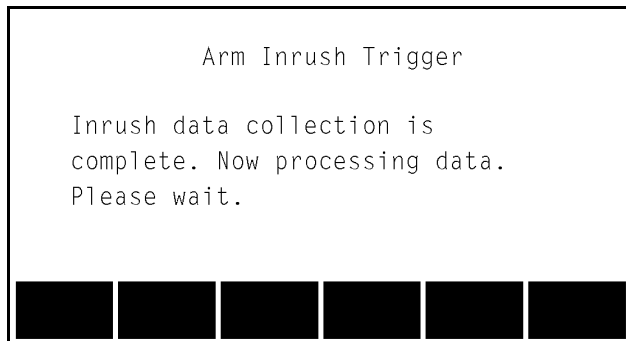

---

## When processing is complete

When data processing is complete, The envelope time plot screen will be displayed automatically. Refer to page 7-2.

---

# Chapter 7

## Viewing Data

### Overview

---

**Introduction** Display of inrush data is only available if data has been recorded. You can view the data in three modes: Envelope Plot, Scope Plot, or Data.

When viewing the envelope plot, you can select from 16 parameters to display the value of the data over time. The scope plot displays the voltage or current waveforms through the recording duration. In data mode, there are four functions that are available to display information about the left most cycle of the waveform display.

When viewing either the envelope or scope plot, you can zoom in to a number of cycles, or a single cycle, by using the function keys. Once partially or fully zoomed in, you can scroll left or right, to view cycles occurring before or after the current cycle(s).

---

**In this chapter** The following topics are discussed in this chapter.

Topic	See Page
Envelope Plot	7-2
Scope Mode	7-4
Zoom	7-5
Scroll	7-9
Data Channel Selection	7-10
Envelope Parameters	7-12
Data Menu	7-14

---

# Envelope Plot

**Screen description**

For the Envelope plot, you can select from 16 parameters to display the value of the data over time. The default parameter is V RMS for channel A.

**Screen A**

The following screen is displayed automatically after data collection is complete, or by selecting item 4, Display Data, from the Main Menu.

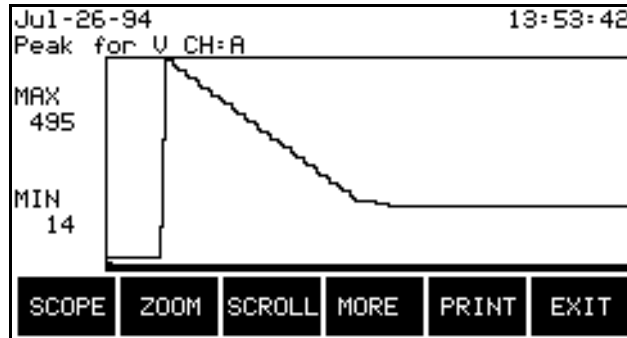

**Screen B**

Screen B has the same display as Screen A, but a different menu bar. Press the MORE key on Screen A to change the menu bar.

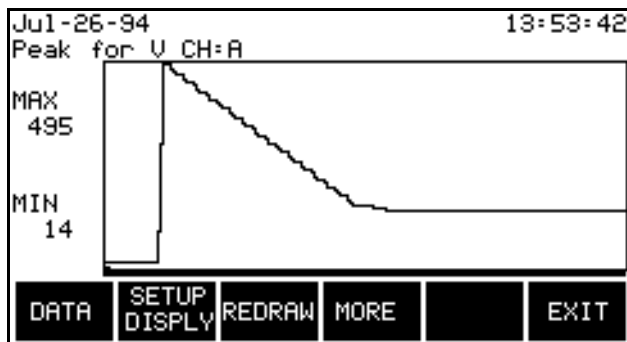

*Continued on next page*

## Envelope Mode, Continued

---

**Function keys**     The following table describes the function keys for the Envelope plot screens.

<b>Key</b>	<b>Description</b>
SCOPE	Displays the scope mode screen. See page 7-4.
ZOOM	Displays the zoom menu bar. See page 7-5.
SCROLL	Displays the scroll menu bar. See page 7-9.
MORE	Toggles between Screen A and Screen B.
PRINT	Prints the displayed waveforms along with the min/max values, number of cycles displayed, and the starting and ending cycle numbers.
DATA	Displays the Inrush Data Menu. See page 7-14.
SETUP DISPLY	Displays the Inrush Channel Selection screen. See page 7-10.
REDRAW	Displays the data through the entire recording duration.
EXIT	Returns to the Main Menu.

---

# Scope Mode

**Screen description**

The Scope plot displays the voltage or current waveforms through the recording duration.

**Screen A**

The following screen is displayed by pressing the SCOPE key on the envelope screen.

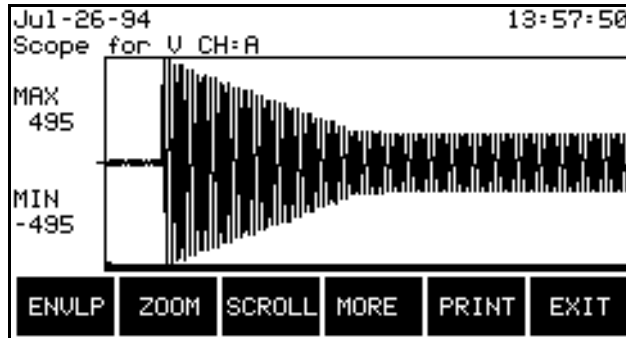

**Screen B**

Screen B has the same display as Screen A, but a different menu bar. Press the MORE key on Screen A to change the menu bar.

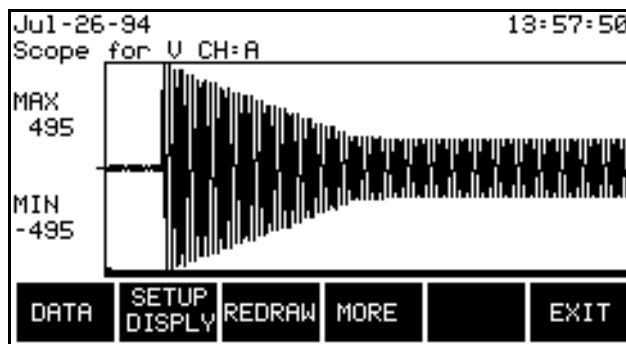

**Function keys**

The following table describes the function keys for the scope plot screens.

Key	Description
ENVLP	Displays the Envelope Mode screen. See page 7-2.
All other function keys operate the same as in Envelope Mode.	

# Zoom

## Introduction

The zoom function allows you to expand the horizontal axis of the envelope or scope plot in order to see it in greater detail. You may repeatedly zoom in on a plot down to a number of cycles, or a single cycle, by using the function keys. Once partially or fully zoomed in, you can scroll left or right, to view cycles occurring before or after the current cycle(s).

## How to Operate the Zoom Cursors

The cursors will initially be displayed on the left and right edges of the zoom window.

Note: Either zoom cursor will appear on screen only after its respective arrow key is pressed.

Press the  $\text{---}\text{>}$  key to move the left cursor and the  $\text{<---}$  key to move the right cursor.

Initially, both cursors will move inward. If one is moved so that it meets the other cursor, subsequent presses will move it outward.

## Procedure

Follow these steps to operate the zoom function. The zoom function can be accessed from the envelope or scope screen. The example screens in the following procedure are from the scope screen.

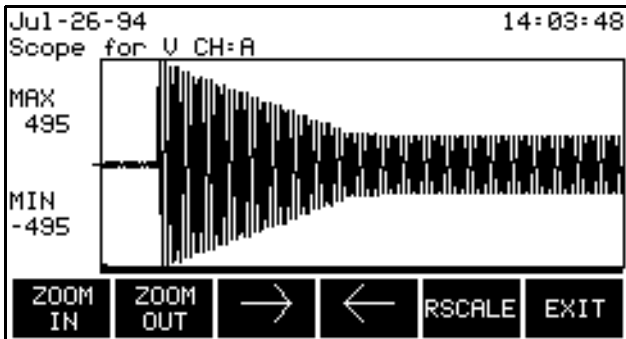
Step	Action
1	<p>From the scope or envelope screen, press ZOOM.</p> <p><u>Result:</u> The menu bar changes to the following.</p> 

*Continued on next page*

## Zoom, Continued

### Procedure (continued)

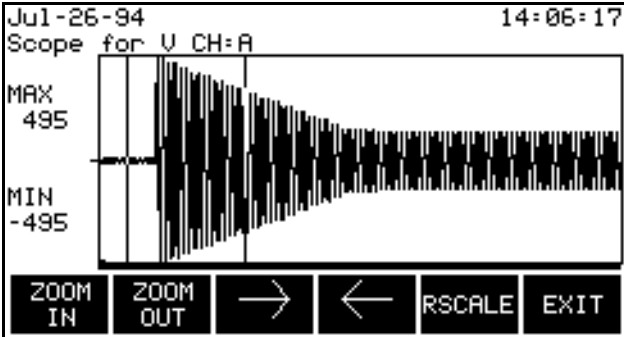
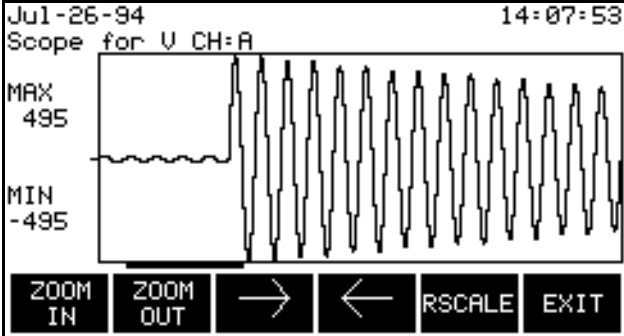
Step	Action
2	Select a section of the plot using the zoom cursors. 
3	Press ZOOM IN. <p><u>Result:</u> The portion of the plot between the zoom cursors will now fill the entire screen.</p> 
4	Repeat steps 2 to 3 for finer resolution.
5	Press ZOOM OUT to re-draw the plot to the previous level.

*Continued on next page*



## Zoom, Continued

**Function keys** The following table describes the function keys for the Zoom screen.

Part	Function
ZOOM IN	Activates the zoom function, based on the position of the vertical cursor lines.
ZOOM OUT	Will display the data at one previous zoom level.
→	Steps the left zoom cursor to the right. When the cursor has moved as far as it can to the right, pressing this key will move it to the left.
←	Steps the right zoom cursor to the left. When the cursor has moved as far as it can to the left, pressing this key will move it to the right.  <u>Note:</u> Either zoom cursor will appear on screen only after its respective arrow key is pressed.
RSCALE	Rescales the displayed data. The zero for the y-axis is either placed in the middle of the axis, or suppressed so that the scaled waveform fills the vertical axis.
EXIT	Returns to Envelope or Scope screen.

### Ratio Bar

The thicker horizontal line on the bottom of the display is the ratio bar and it represents the portion of the entire recording duration that is occupied by the current display.

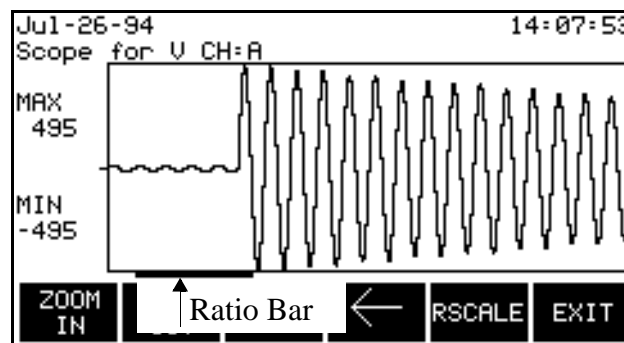

*Continued on next page*

## Zoom, Continued

**Pre-trigger bar** The pre-trigger bar appears at the bottom of the screen above the ratio bar and identifies the pre-trigger cycle(s).

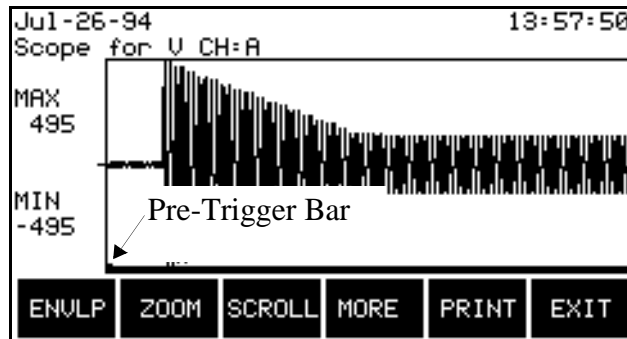

When the display is zoomed in on as shown below, the pre-trigger bar is easily seen, indicating one pre-trigger cycle.

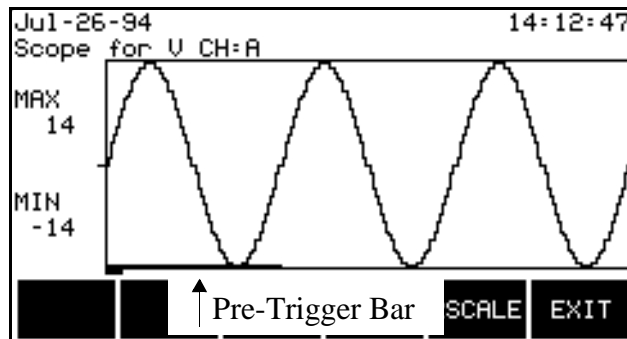

# Scroll

**Screen description**

This screen allows you to display cycles that occurred before or after the cycle(s) currently displayed.

**Note**

The display must be zoomed for the scroll function to work.

**Displaying the screen**

Follow these steps to display the scroll screen.

Step	Action
1	If the zoom menu bar is still displayed, press EXIT.
2	Press SCROLL.  <u>Result:</u> A screen similar to the following.

The screenshot shows a digital oscilloscope screen. At the top left, it displays 'Jul-26-94' and at the top right, '14:11:28'. Below the date, it says 'Scope for U CH:A'. The main area shows a waveform with two distinct peaks. On the left side of the waveform, 'MAX 495' and 'MIN -495' are displayed. At the bottom of the screen, there is a control bar with several buttons: a right-pointing arrow, a left-pointing arrow, 'RSCALE', and 'EXIT'.

**Function keys**

The following table describes the function keys for the Scroll screen.

Part	Function
→	Changes the display to show cycles that occurred after those presently displayed. Pressing this key moves the ratio bar to the right.
←	Changes the display to show cycles that occurred before those presently displayed. Pressing this key moves the ratio bar to the left.
RSCALE	Rescales the displayed data. The zero for the y-axis is either placed in the middle of the axis, or suppressed so that the scaled waveform fills the vertical axis.
EXIT	Returns to Envelope or Scope screen.

## Data Channel Selection

---

**Screen description**

This screen provides you with the option of specifying which channels of the y-axis parameter will be displayed on either the Envelope or Scope screens.

---

**Called from**

If a non-power parameter is displayed on the Envelope or Scope screen, pressing SETUP DISPLY displays Screen A. If a power parameter is displayed on the Envelope or Scope screen, pressing SETUP DISPLY displays Screen B.

---

**Screen A**

```
Aug-03-93 15:51:22
MOTOR IN-RUSH CHANNEL SELECTION

Y-AXIS PARAMETER : PEAK
CHN VOLTS AMPS
A ON OFF
B OFF OFF
C OFF OFF
D OFF OFF

NEXT VOLTS AMPS PARAM EXIT
CHAN
```

---

**Screen B**

```
Aug-03-93 15:53:51
MOTOR IN-RUSH CHANNEL SELECTION

Y-AXIS PARAMETER WATTS
CHN
A ON
B OFF
C OFF
D OFF

NEXT ON/OFF PARAM EXIT
CHAN
```

---

**Note**

Only channels that have data collected can be turned ON.

---

## Data Channel Selection, Continued

**Function keys**

The following table describes the function keys for the Data Channel Selection screen.

<b>Key</b>	<b>Description</b>
NEXT CHAN	Moves the highlight to the next channel. After D goes to A.
VOLTS ON/OFF (Screen A only)	Toggles the voltage channel of the highlighted channel between ON and OFF.
AMPS ON/OFF (Screen A only)	Toggles the voltage channel of the highlighted channel between ON and OFF.
ON/OFF (Screen B only)	Toggles the y-axis parameter of the highlighted channel between ON and OFF.
PARAM	Displays Inrush Envelope Parameters screen. See page 7-12.
EXIT	Returns to Envelope or Scope screen.

# Envelope Parameters

**Screen description**

This screen allows you to choose the y-axis parameter for the envelope plot.

**Screen**

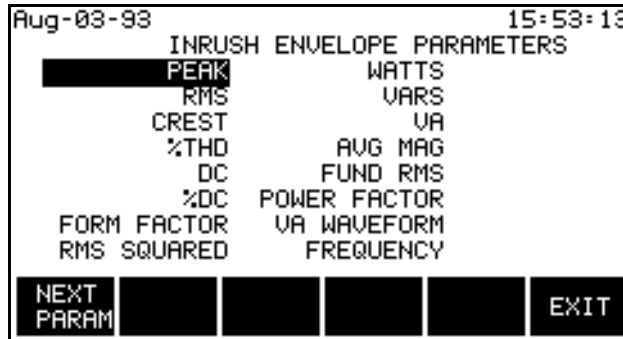

**Function keys**

The following table describes the function keys for the Envelope Parameters screen.

Key	Description
NEXT PARAM	Moves the highlight to the next parameter on the list.
EXIT	Returns to Data Channel Selection screen, and accepts the new display parameter.

**Note**

The scope plot will automatically display voltage and current waveforms if one of the power parameters is selected. For example, if you were viewing peak voltage on channel A only, and then switched the parameter to watts, the scope plot would then display voltage and current for channel A.

*Continued on next page*

## Envelope Parameters, Continued

### Inrush Envelope Parameter Formulas

The following table lists the formulas that the PPI-Inrush uses to calculate the corresponding envelope plot.

Parameter	Formula
Peak	Largest absolute value sample in cycle.
RMS	$\sqrt{\frac{\sum peak_n^2}{samples - per - cycle}}$
Crest	$\frac{peak}{RMS}$
% THD	$\left( \sqrt{\frac{RMS_{total}^2 - RMS_{fund}^2 - dc^2}{RMS_{fund}^2}} \right) 100\%$
DC	Average value over cycle.
%DC	$\frac{dc}{RMS} 100\%$
Form Factor	$\frac{RMS}{averagemagnitude}$
RMS Squared	$RMS^2$
Watts	$\frac{\sum (V_{inst} \cdot I_{inst})}{samples - per - cycle}$
VARs	$\sqrt{VA^2 \cdot watts^2}$
VA	$V_{RMS} \cdot I_{RMS}$
Avg Mag	$\frac{\sum  sample _n}{samples - per - cycle}$
Fund RMS	$RMS_{fund}$
Power Factor	$\frac{watts}{VA}$
VA Waveform	$V \cdot I$ for each sample
Frequency	Measured from incoming voltage signal.

# Data Menu

---

**Screen description**

The Data mode will display information about the left most cycle on the envelope or scope plot. You select one of four displays, identical to those used in meter mode: All Channels, All Parameters report; Scope Mode; Voltage and Current Phasors; or Harmonics for V, I, and W.

---

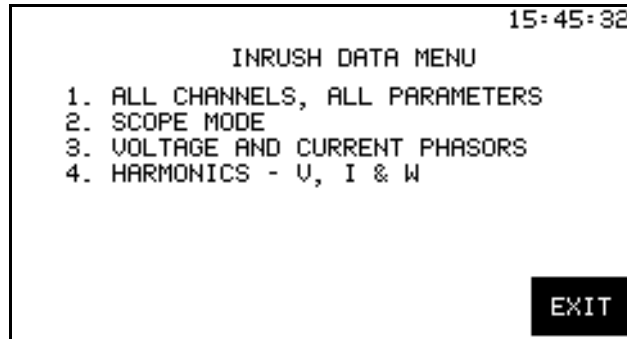
**Screen**

---

**Menu items**

The following table describes the menu items for the inrush Data Menu.

Item	Description
1	Displays the All Channels, All Parameters report. See page 3-50.
2	Displays Scope Mode. See page 3-47.
3	Displays Voltage and Current Phasors. See page 3-52.
4	Displays Harmonics for V, I, and W. See page 3-53.

---

**EXIT**

Pressing EXIT returns you to the Envelope or Scope screen.

---



# Chapter 8

## Memory Card Functions

### Overview

---

**Available functions** The Memory Card Functions screen allows you to write to, read from, and format a memory (data) card. In addition the screen provides information about the card size, available space, write protection, and battery status.

---

**Memory Card Functions screen** From the Main Menu, select item 6, Memory Card Functions, to display the following screen.

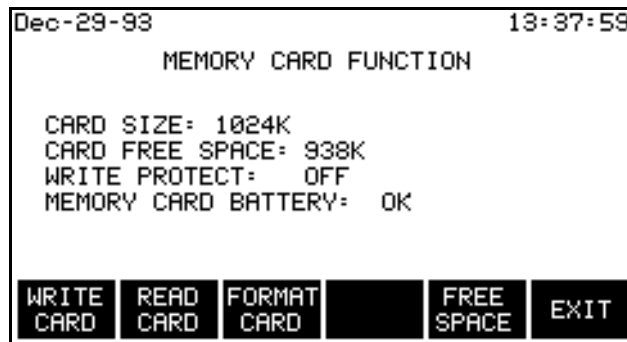

**Memory card description** Refer to page 1-8 for a description of the memory card.

---

**Converting the files to ASCII** The files on the data card can be copied to your PC and then converted to ASCII with the program on the supplied disk, MIR-UTIL-ASCII. Once the files are converted, they can be imported into spreadsheet and word processing programs for graphing and inclusion in reports. Operating instruction for the ASCII utility are contained in the README file on the program disk.

---

**In this chapter** The following topics are covered in this chapter.

Topic	See Page
Write to Memory Card	8-2
Read Memory Card	8-5
Format Memory Card	8-6

---

# Write to Memory Card

## Screen

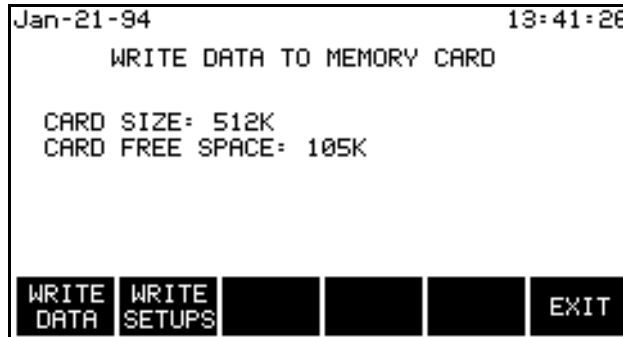

## Function keys

The following table provides a description of the function keys for the Write Data to Memory Card screen.

Key	Function
WRITE DATA	Displays the message “Writing to Data Card, Please Wait” and writes all data to the card. If there is insufficient space on the card, an error message will be displayed, with a beep. The Card Free Space value is updated when complete.
WRITE SETUPS	Displays the message “Writing to Data Card, Please Wait” and writes all configurations and threshold setups to the card. Refer to the next page for a list of what is written. If there is insufficient space on the card, an error message will be displayed, with a beep. The Card Free Space value is updated when complete.
EXIT	Returns to Memory Card Functions screen.

## How the files are written

If a file does not exist pressing WRITE DATA or WRITE SETUPS creates a file with the name *filename*.INR (data) or *filename*.IST (setups), where *filename* is the first eight characters of the site name. If a file already exists, it is overwritten with the new data.

*Continued on next page*

## Write to Memory Card, Continued

---

**CAUTION** Data could be lost if multiple data sets are collected at one site and saved to one card. To avoid loss of data, change the site name each time new data is collected from the same site. Refer to page 4-2 for information about changing the site name.

---

**PRECAUCIÓN** Se podrían perder datos si se recogen múltiples juegos de datos en un lugar y se guardan en una tarjeta. Para evitar la pérdida de datos, cambie el nombre del lugar cada vez que se recojan datos nuevos desde el mismo lugar. Consulte la página 4-2 para información acerca del cambio de nombre del lugar.

---

**MISE EN GARDE** Des données pourraient être perdues si plusieurs ensemble de données sont collectés sur un seul site et sauvegardés sur une seule carte. Pour éviter la perte de données, changez le nom du site chaque fois que de nouvelles données sont collectées à partir du même site. Reportez-vous à la page 4-2 pour plus d'informations concernant le changement du nom de site.

---

**VORSICHT** Datenverlust kann auftreten, wenn mehrere Datensätze in einer Stelle gesammelt werden und auf eine Karte gespeichert werden. Ändern Sie den Stellennamen jedesmal, wenn neue Daten von der gleichen Stelle gesammelt werden, um dadurch Datenverlust zu verhindern. Lesen Sie dazu Seite 4-2 für Informationen zur Stellennamen-Änderung.

---

*Continued on next page*

## Write to Memory Card, Continued

---

- What is written** The following configurations and setups are written to the data card when WRITE SETUPS is pressed:
- Analog configuration:
    - Present input channels configuration
    - Present wiring configuration (for ABC totals)
    - Present scale factors.
  - Digital configuration
  - RMS thresholds.
  - Site name.
  - Other devices configuration.
  - Trigger setup:
    - trigger type
    - number of pre-trigger cycles
    - sample/cycle
    - recording duration.
- 

**Reloading setups** These settings may be reloaded from the card back into the PP1 to restore the instrument to these settings.

---

# Read Memory Card

## Screen

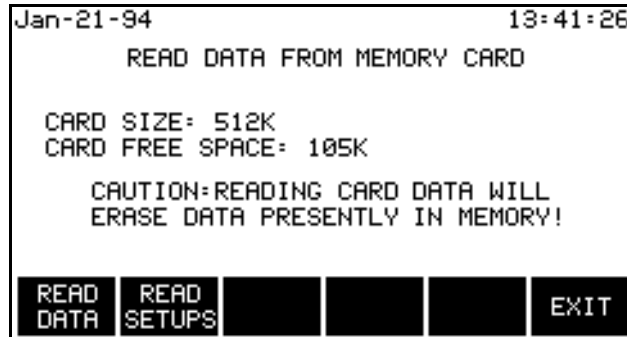

## Function keys

The following table provides a description of the function keys for Read Data from Memory Card screen.

Key	Function
READ DATA	Reads all data to internal memory from the card. Existing data in memory will be overwritten.
READ SETUPS	Reads all setups and configurations into internal memory. See page 8-3 for the list of what is read.
EXIT	Returns to the Memory Card Functions screen.

## Note

The first eight characters of the site name must match the filename on the memory card or else the Power Platform will not be able to read it.

# Format Memory Card

---

## Screen

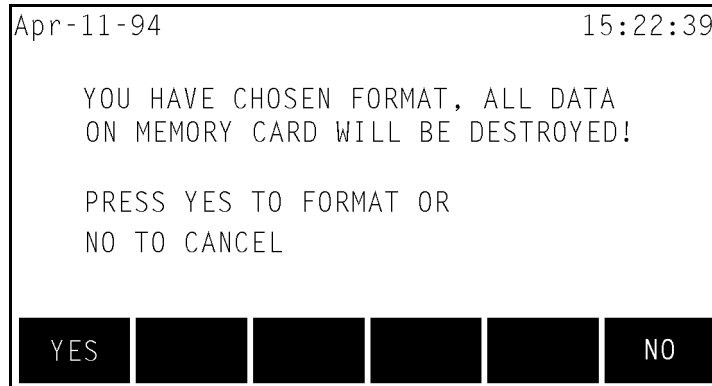

## Function keys

The following table provides a description of the function keys for Format Memory Card screen.

Key	Function
YES	Formats data card and displays the following message: "Formatting and verifying data card. Please wait." When format is complete, returns to screen Memory Card Functions screen.
NO	Return to Memory Card Functions screen and does not format card.

---

# Chapter 9

## Printer Operation

### Overview

---

**Introduction** The Power Platform with a built-in thermal printer produces high resolution graphic or text output of 320 dots per line at one inch per second. Printing is done either automatically or manually. Automatic printing occurs for operator programmed triggering of reports or when error messages are generated. Manual printing is operator controlled with the PRINT key that is located on various screens.

---

**In this chapter** The following topics are covered in this chapter.

Topic	See Page
Printer Controls	9-2
Normal Operation	9-5
Paper Replacement	9-7

---

# Printer Controls

## Introduction

Printer controls are located on the front panel as well as in software. The printer assembly and its front panel controls are shown below.

## Printer assembly

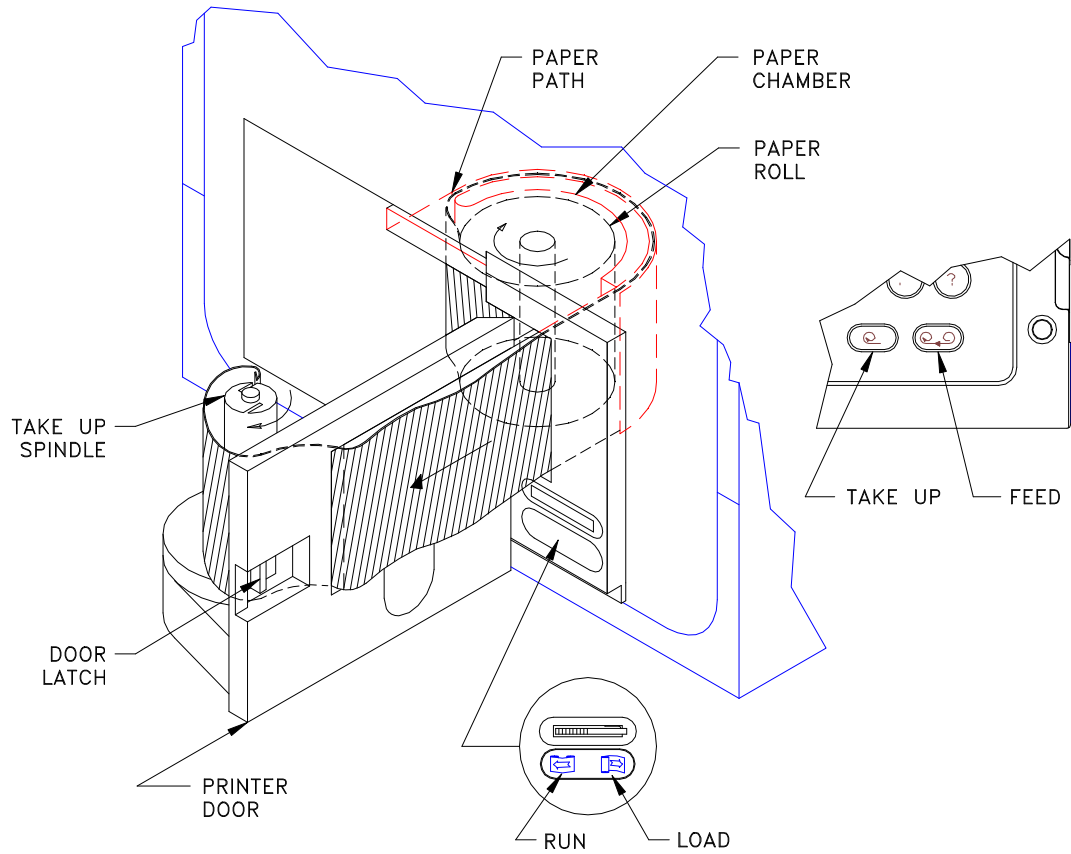

8000-13

*Continued on next page*



## Printer Controls, Continued

### Front panel controls

The following table provides a description of the front panel printer controls.

<b>Part</b>	<b>Function</b>
Run/Load lever	Used to raise and lower the printhead. <ul style="list-style-type: none"><li>• In normal operation the lever is left in the RUN position.</li><li>• With the lever in the LOAD position, printing is disabled and the printer paper may be removed or loaded.</li></ul>
Take-up button	Removes slack in the printer paper when pressed.  The take-up feature stops under the following conditions: <ul style="list-style-type: none"><li>• when there is some paper resistance, or</li><li>• within ten seconds if the paper is torn or disconnected from the take-up spindle and the RUN/LOAD lever is in the RUN position.</li></ul>
Feed button	Advances the paper when pressed.

*Continued on next page*

## Printer Controls, Continued

### Software controls

The printer software controls are located on the Other Devices Configuration screen.

Displaying the screen: Follow these steps to display the screen.

Step	Action
1	From the Main Menu, select item 3, Setup Menu.
2	From the Setup Menu, select item 8, I/O Devices.
3	From the I/O Devices menu, select item 6, Other Devices.  <u>Result:</u> The following screen will appear.

```

Jan-20-94                               13:37:35
      OTHER DEVICES CONFIGURATION
LCD BACKLIGHT AUTO-SHUTOFF: ENABLED
PRINTR ON/OFF: ON
PRINTR BATTERY OPERATION: TIME LIMIT
AUDIBLE ALARM ON/OFF: ON
LCD DISPLAY MODE: NORMAL
<press 1 to change>
BACK  PRINTR PRINTR ALARM  PRINT  EXIT
LIGHT ON/OFF BATTERY ON/OFF
    
```

Function keys: The following table provides a description of the printer related functions keys for the Other Devices configuration screen.

Key	Function
PRINTR ON/OFF	Turns printer on or off when pressed.
PRINTR BATTERY	Selects one of three operating modes when pressed: <ul style="list-style-type: none"> <li>• Instant Off turns the printer off immediately after AC power loss</li> <li>• Time Limit turns the printer off 15 minutes after AC power loss</li> <li>• No Limit allows the printer to operate until the battery is completely depleted.</li> </ul>

Note: The EXIT key must be pressed for either selection to take effect.

# Normal Operation

---

**Introduction** To operate the printer normally (not running off the internal battery), the following conditions must be met:

- The printer must be turned on
- The RUN/LOAD lever must be in the RUN position.
- The printer must have paper.

Manual control of the printer from the function keys or the keypad and automatic printing of reports and error messages can now take place.

---

**Manual printing** Manual operation of the printer consists of selecting PRINT from the menu bar at the bottom of a screen (such as the Other Devices Configuration screen shown on the previous page) or pressing the correct number on the keypad for a menu screen that has a print selection. Pressing keypad number 7 for the screen shown below is an example of keypad print selection.

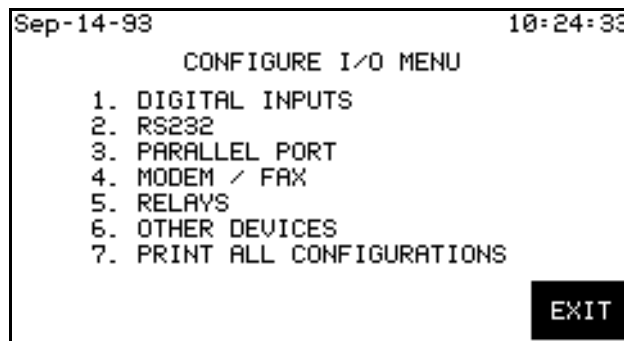

**Automatic printing** Automatic printing occurs when reports or error messages are generated. Report generation is controlled by the user; error message generation is not. Reports are printed automatically when user defined trigger conditions are met. Refer to Chapter 8 for more information.

---

**Printout storage** During printing, the paper is collected on the internal take-up spindle for storage and future review. Stored printouts can be viewed by inserting a finger into the finger groove, so that it is behind the paper tape, and pulling the paper tape straight out from the printer door. When finished viewing the earlier data, press the TAKE-UP pushbutton to remove the slack. If long lengths of paper are outside the Power Platform, be sure to keep paper from being twisted when using the paper take-up feature.

---

*Continued on next page*

## Normal Operation, Continued

---

**CAUTION** Never grasp the printer paper and try to pull it out from the printhead with the RUN/LOAD lever in the RUN position. Damage to the printhead will result.

---

**PRECAUCION** Nunca tire del papel de impresora desde el cabezal de impresión con la palanca RUN/LOAD en la posición RUN. Puede ocasionar daños al cabezal de impresión.

---

**MISE EN GARDE** Ne jamais tirer le papier de la tête d'impression lorsque le levier RUN/LOAD est en position RUN. La tête d'impression serait endommagée.

---

**VORSICHT** Greifen und ziehen Sie nie das Druckpapier vom Druckkopf, wenn der "RUN/LOAD"-Hebel (Laufen/Laden-Hebel) sich in der RUN-Position (Laufen) befindet. Der Druckkopf kann beschädigt werden.

---

**Snapshot printing** Snapshot (single print) printing is used in the meter mode, scope mode, harmonic analysis, etc. These individual events are manually printed and are generally collected and cataloged into notebooks, ledgers, etc. Snapshot prints are separated from the print roll by tearing at the right edge of the printer window at the end of each print cycle.

Since snapshots are printed without the take-up motor engaged, the motor will run during each print cycle (approximately five seconds).

---

## Paper Replacement

---

**Paper low condition**

The last 40 inches of paper is marked with a red stripe on the top and bottom edges. When the printer is out of paper, or the print head is up, the PP1-Inrush will buffer the printouts until it can print again or until it runs out of memory.

---

**CAUTION**

**To avoid damage to the printhead when loading or removing paper, the RUN/LOAD lever must be in the LOAD position.**

---

**PRECAUCION**

**Para evitar daños al cabezal de impresión cuando cargue o retire papel, la palanca RUN/LOAD debe estar en la posición LOAD.**

---

**MISE EN GARDE**

**Pour éviter d'endommager la tête d'impression lors de la mise en place et du retrait du papier, le levier RUN/LOAD doit être en position LOAD.**

---

**VORSICHT**

**Um während des Ladens oder Entfernens von Papier Beschädigung am Druckkopf zu verhindern, muß der "RUN/LOAD"-Hebel sich in der "LOAD"-Position (Laden) befinden.**

---

**Removing old paper roll**

Follow these steps to remove an old paper roll.

Step	Action
1	If paper is low, but not out, press the paper FEED pushbutton until only blank paper is showing.
2	Pull the paper out for slack and tear the paper on the right edge of the printer window.
3	Set the RUN/LOAD lever to the LOAD position.
4	Press the printer door latch to the right and open the door until it locks in place.
5	Remove the paper from the take-up spindle by tightly grasping the paper on the spindle, turning it clockwise, and gently pulling the paper up and off the spindle.
6	If there is paper remaining in the paper path, gently pull this paper out of the printer mechanism.
7	Remove the empty paper spool and any remaining paper from the paper chamber.

---

## Paper Replacement, Continued

---

**CAUTION** Using thermal paper other than that supplied by Dranetz-BMI or its authorized representatives may damage the printhead.

---

**PRECAUCIÓN** El uso de papel térmico que no sea el suministrado por Dranetz-BMI o sus representantes autorizados puede causar daños a la impresora.

---

**MISE EN GARDE** L'utilisation d'un papier thermosensible différent de celui fourni par Dranetz-BMI ou par ses représentants autorisés peut endommager l'imprimante.

---

**VORSICHT** Nur das von Dranetz-BMI oder seinen Vertretungen gelieferte Thermopapier benutzen. Anderes Papier kann den Drucker beschädigen.

---

**Before loading new paper roll** Follow these steps before you load a new paper roll.

Step	Action
1	Remove the new paper roll from its box and remove any wrapping.
2	If the end of the paper roll is glued down, cut off glued portion.
3	Unroll approximately 12 inches of paper.
4	Verify that the RUN/LOAD lever is in the LOAD position.

---

**Loading new paper roll** Follow these steps to load a new paper roll.

Step	Action
1	Center the paper roll on the white nub on the bottom of the paper chamber with the loose end coming out clockwise from the back of the paper roll. See page 9-2 for paper routing.
2	Insert the end of the paper into the paper path slot to the left of the paper roll.
3	Feed the paper through the path until it comes out the front of the printer door.

---

*Continued on next page*

## Paper Replacement, Continued

---

### Loading new paper roll (continued)

Step	Action
4	Hold the paper against the spindle while rotating the bottom of the spindle at least two turns clockwise.
5	Move the end of the paper across the front of the printer door (from right to left) and guide it through the slot near the take-up spindle.
6	Move the end of the paper across the front of the printer door (from right to left) and guide it through the slot near the take-up spindle.

---

### After loading new paper roll

Follow these steps after loading a new paper roll.

Step	Action
1	Set the RUN/LOAD lever to the RUN position. <u>Note:</u> Printer will not work if this lever is in the LOAD position.
2	Press the paper take-up pushbutton and note that all slack in the printer paper is removed, the paper is taut and the take up motor stops.
3	If the take up motor continues to spin, the paper is not engaged correctly. Repeat step 5 of the previous procedure.
4	Press the paper FEED pushbutton to ensure the paper advances freely across the printer door without slipping or stopping.
5	If the paper does not feed smoothly, remove the paper and repeat “Loading new paper roll” procedure on the previous page.
6	Close the printer door.

---

### Ordering thermal paper

Contact Dranetz-BMI or your authorized Dranetz-BMI representative to order thermal paper (P/N 115323-G1) for the Power Platform thermal printer.

---





# Appendix A

## Optional Accessories

---

**In this appendix** The following topics are covered in this appendix.

Topic	See Page
Optional Accessories List	A-2
Optional Accessories Descriptions	A-4

---

## Optional Accessories List

---

<b>Accessory</b>	<b>Part Number</b>
Power Quality Plus, TASKCard (English)	TASK-PQPlus-E
Power Quality Plus, TASKCard (Spanish)	TASK-PQPlus-S
Power Quality Plus, TASKCard (French)	TASK-PQPlus-F
8000, TASKCard	TASK-8000
Inrush, TASKCard	TASK-Inrush
Communications and Analysis Software	PCPP1
Field Handbook for Electrical Energy Management	HB114415
Service Manual	SM-PP1
Clamp-on Current Probe, 1 to 10 A	CT-10
Clamp-on Current Probe, 15 to 150 A	CT-150
Clamp-on Current Probe, 30 to 300 A	CT-300
Clamp-on Current Probe, 100 to 1000 A	CT-1000
Clamp-on Current Probe, 300 to 3000 A	CT-3000
Isolated Current Transformer Box, 1A	ISO-1A
Isolated Current Transformer Box, 5A	ISO-5
Memory Card Reader, Serial Port	
Memory Card Reader, Serial Port, 230 V	
Memory Card Reader, Parallel Port	
Memory Card Reader, Parallel Port, 230 V	
Memory Card Reader, Data Bus Plug-in	
Memory Card, 512k	CARD-512
Memory Card, 1M	CARD-1M
Memory Card, 2M	CARD-2M
Box of Thermal Paper (16 rolls)	CTP-16
External DC Battery Filter	XBF-12
External Battery Charger	

---

*Continued on next page*

## Optional Accessories List, Continued

List (continued)

---

Accessory	Part Number
External Modem Interface Cable	XMC-8
RS-232 Cables, 25-pin M to 25-pin F, and a 25-pin M to 9-pin F adapter cable.	RSCOM
Soft Carrying Case (with probe pallet)	SCC-8
Reusable Shipping Case	RSC-8
Battery Pack, Field Replaceable	FBP-8
Internal Modem, 2400 Baud (not available on PP1E)	MDM24
Adapter Cable, 808 Probe to PP1 (see page A-6) (not available with PP1E)	115551-G1
Adapter Cable, 658 Probe to PP1 (see page A-6)	115552-G1

---

## Optional Accessories Descriptions

---

### **Current probes and isolation current transformers**

Current Probes: There are five clamp-on current probes, models CT 10, CT150, CT300, CT1000, and CT3000 used to measure ACrms currents up to a maximum of 10A, 150A, 300A, 1000A, and 3000A, respectively.

Isolation Current Transformers: Two isolation current transformers (ISO boxes), models ISO-1A (2Arms max) and ISO-5 (10Arms max) provide low level isolation nominal currents of 1Arms and 5Arms, respectively, for connection to low current devices or for connection to current probes of other manufacturers.

Either the clamp-on current probes or the isolation transformers can be connected to any one of the four current jacks on the Power Platform rear panel. A decal sheet is provided to allow color coding of the probes and transformers that correspond to the rear panel jacks.

---

### **Internal 2400 baud modem**

The MDM24 option consists of a Hayes compatible 2400 Baud modem installed on the I/O controller board and a 25 foot modular plug/cable assembly for connection to telephone lines. Normally installed at factory when unit is originally purchased.

---

### **TASKCard-8000**

The 8000 TASKCard changes the Power Platform to a power quantity monitor so that it measures, records, and displays electric power parameters to help you find inefficiencies in your electric system.

---

### **RSCOM cables**

The RSCOM cables consist of two RS232 cables, one 10' long, the other 1' long. The ten foot cable has a 25-pin male connector and a 25-pin female connector. The one foot adapter cable has a 25-pin female connector and a 9-pin male connector for serial data connections. The cables permit the PP1-PQPlus to communicate with a terminal, computer, external printer, or external modem.

---

### **Memory cards**

Several types of memory cards are available, from 512 kilobytes to 2 megabytes. A memory card is read by your PC with a memory card reader, also available as an option.

---

*Continued on next page*

## Optional Accessories Descriptions, Continued

---

**Memory card readers** Three types of memory card readers are available as options. Each reader provides a different means of communications with an IBM compatible computer. The three types are: RS232 port, parallel port, and data bus plug-in.

---

**External battery charger** The optional external battery charger provides an alternate means for charging the FBP-8 battery pack or additional battery packs.

---

**PCPP1** This is a Windows based program that is used to access and retrieve data from single or multiple remote Dranetz-BMI Power Platforms. Other features include totalization of demand and energy data from multiple units, manipulation of time plot data, and the ability to read data from a memory card if your PC is equipped with a memory card reader.

---

**Handbook for Energy Management** This optional reference handbook provides a comprehensive guide for information related to conducting a thorough energy audit, power distribution analysis, and methods of remedying inefficiencies of energy management.

---

**Adapter cables** Two types of adapter cables are available to permit connecting current probes of Dranetz-BMI models 808 and 658 to the PP1 current input jacks. These adapter cables are shown on the following page. Supplied with these cables is an information sheet (P/N 899009) that describes the cables and the scale factors of the respective current probes used with the cables.

---

**Ordering information** To order accessories, contact Dranetz-BMI Customer Service.

**Telephone:** 1-800-372-6832 or 732-287-3680

**Fax:** 732-248-1834

**Web site:** [www.dranetz-bmi.com](http://www.dranetz-bmi.com)

---

## Optional Accessories Descriptions, Continued

---

**Adapter cable,  
808 to PP1,  
P/N 115551-G1  
(not available  
on PP1E)**



**Adapter cable,  
658 to PP1,  
P/N 115552-G1**



## Appendix B

### Repacking for Return Shipment

**Introduction** If the unit must be returned to Dranetz-BMI for service or repair, repack the unit in its original shipping carton as shown below. Do not return the Power Platform in an unpacked box. Dranetz-BMI will not be responsible for damage incurred during transit due to inadequate packing on your part.

**Return notice** Notify Dranetz-BMI Customer Service of your intention to return the unit. Do not return the unit without prior instructions from Dranetz-BMI Customer Service, telephone 732-287-3680 or 1-800-372-6832.

#### Original shipping carton

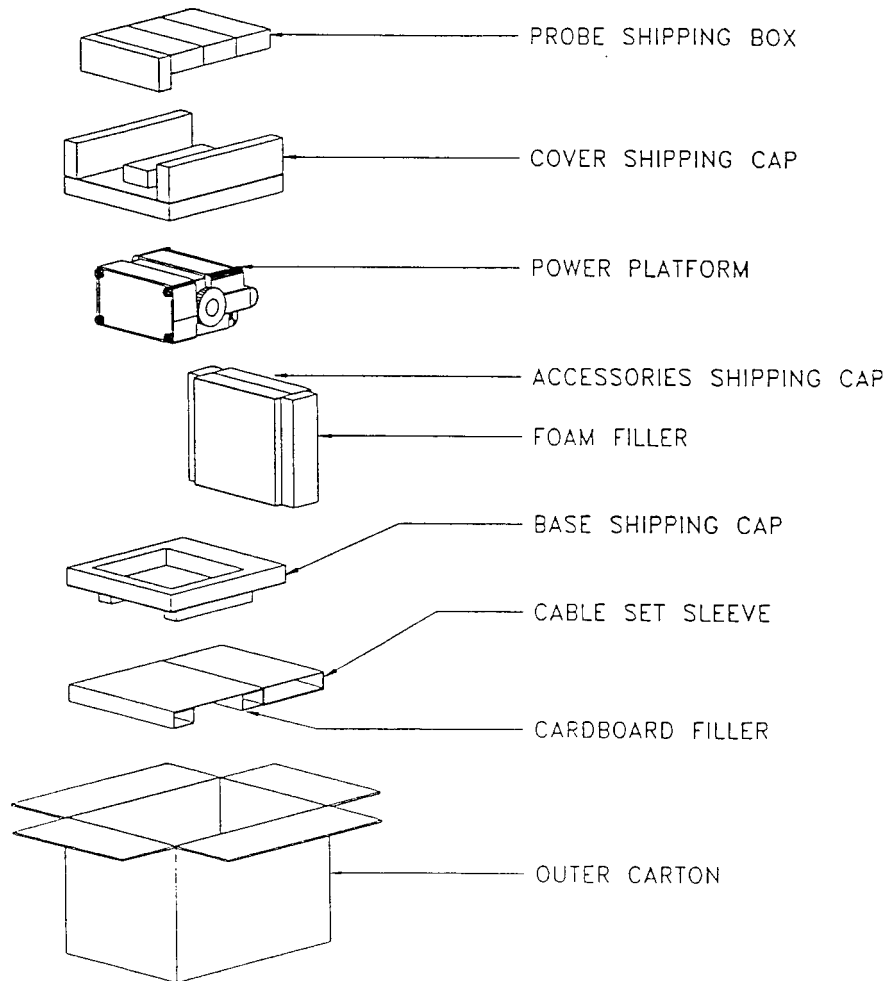

8600-31





# Appendix C

## Battery Specifications and Replacement Procedure

### Overview

---

**Introduction** The internal battery pack used in the Power Platform functions as the uninterruptible power supply (UPS) in the event of AC power loss. It can also function as the primary power source when no AC power source is available.

The Power Platform also contains a lithium battery for memory backup.

---

**In this appendix** The following topics are covered in this appendix.

Topic	See Page
Battery Specifications	C-2
Battery Pack Safety Precautions	C-3
Battery Pack Replacement	C-5
Memory Card Battery Replacement	C-6

---

## Battery Specifications

---

### Battery Pack

Location: battery compartment on the top front of the unit

Number of cells: 10

Type: sealed, rechargeable NiCad cells

Voltage: 12 V DC

Capacity: 2.5 Ah

Length of operation: One hour of monitoring only operation when fully charged, or up to 15 minutes of continuous printer operation.

Suggested replacement interval: two years.

---

### Note

The length of time that the Power Platform can operate on the battery pack degrades over the life of the batteries and the number of charge/discharge cycles.

---

### Lithium Battery Power Module

A Lithium Battery Power Module is mounted on the CPU board and is used for memory backup of the PP1-Inrush configurations and setups.

3 V, 1000 mAh Lithium battery for data retention with an estimated life of 2 years (operational), 1 1/2 years (storage). Replacement recommended during each Dranetz-BMI calibration procedure.

The Lithium battery is not operator replaceable. Refer to the Power Platform service manual, SM-PP1, for replacement procedures by qualified service personnel.

---

## Battery Pack Safety Precautions

---

**WARNING**      **DO NOT intentionally short circuit the battery pack. The batteries are capable of producing hazardous output currents if short circuited. The Power Platform is equipped with an internal battery charger circuit. Do not attempt to charge the batteries with an external charger other than the Dranetz-BMI battery charger, since improper charging could cause battery explosion.**

---

**ADVERTENCIA**      **NO ponga intencionalmente la batería en cortocircuito. Las baterías son capaces de proporcionar corrientes de salida peligrosas si están en cortocircuito. La Power Platform está equipada con un circuito interno cargador de baterías. No intente cargar las baterías con un cargador externo que no sea el cargador de baterías Dranetz-BMI, puesto que la carga indebida podría hacer que explote la batería.**

---

**AVERTISSEMENT**      **NE PAS court-circuiter délibérément le bloc-batterie. Lors d'un court-circuit, les batteries risquent d'émettre des courants effectifs dangereux. "Power Platform" possède un circuit de chargeur de batterie intégré. Ne pas tenter de charger les batteries au moyen d'un chargeur externe autre que le chargeur de batterie Dranetz-BMI, car un rechargement fautif pourrait entraîner l'explosion de la batterie.**

---

**WARNUNG**      **Die Batterien dürfen NICHT kurzgeschlossen werden. Im Falle eines Kurzschlusses können die Batterien lebensgefährliche Ausgangsströme leiten. Power Platform ist mit einem internen Batterieladegerät ausgestattet. Die Batterien sollten nur mit dem Ladegerät von Dranetz-BMI geladen werden. Die Verwendung eines externen Ladegeräts kann zu einer Explosion der Batterien führen.**

---

**Battery Safety Precautions**      The following safety precautions must be adhered to.

- Keep batteries away from children. Never permit a child to play with a battery as an ornament or toy.
- Do not disassemble battery or battery pack.
- Do not dispose of battery in fire.
- Dispose of a used battery promptly in accordance with local Environmental Protection Agency (EPA) regulations.

---

*Continued on next page*

## Battery Pack Safety Precautions, Continued

---

### Battery Safety Precautions (continued)

- Visually inspect the battery pack for corrosion.
- 

### Medidas de seguridad de la batería

Deberán observarse las medidas de seguridad siguientes:

- No deberá mantenerse las baterías al alcance de los niños. No deberá permitirse que un niño juegue con una batería.
  - No deberá desensamblarse ninguna batería ni el compartimiento de la misma.
  - No deberá prenderse fuego a una batería.
  - Toda batería agotada deberá desecharse de manera rápida según las normas locales de la Agencia de protección del medio ambiente (EPA).
  - Deberá verificarse que el compartimiento de las baterías no esté corroído.
- 

### Mesures de sécurité relatives aux batteries

Il est très important de suivre les mesures de sécurité suivantes.

- Ne pas laisser les batteries à la portée des enfants. Ne jamais laisser un enfant jouer avec une batterie.
  - Ne pas démonter de batterie ou de bloc-batterie.
  - Ne pas jeter de batterie dans le feu.
  - Se débarrasser rapidement des batteries usagées en se conformant aux règlements de l'EPA (Agence américaine pour la protection de l'environnement).
  - Inspecter le bloc-batterie à l'oeil nu pour rechercher les signes de corrosion.
- 

### Batterie-Sicherheitsvorkehrungen

Die folgenden Sicherheitsvorkehrungen müssen beachtet werden.

- Halten Sie Batterien von Kindern fern. Erlauben Sie einem Kind unter keinen Umständen, eine Batterie als Verzierung oder Spielzeug zu benutzen.
  - Nehmen Sie Batterien oder Batteriepackungen nicht auseinander.
  - Entsorgen Sie Batterien nicht durch Verbrennen.
  - Entsorgen Sie verbrauchte Batterien umgehend nach den gesetzlichen Umweltschutzbestimmungen.
  - Prüfen Sie die Batteriepackung optisch auf Korrosion.
- 

### Note

The batteries have a safety pressure vent to prevent excessive gas build-up and corrosion indicates that venting has occurred. Possible causes of venting are: a defective charger, excessive temperature, excessive discharge rate, or a defective cell.

If corrosion is excessive, the battery pack may require replacement (contact Dranetz-BMI Customer Service Department).

---

# Battery Pack Replacement

---

**Introduction** The Power Platform contains an easily replaceable internal battery pack. Replacement is recommended when the battery pack can no longer maintain a charge. Depleted battery packs may be charged outside the PP1 by using the optional battery charger. See Appendix A for battery pack ordering information.

---

**Note** During normal operation, the battery pack will be slightly warm to the touch.

---

**Procedure** Follow these steps to replace the battery pack.

<b>Step</b>	<b>Action</b>
1	Set the Power Platform's power switch to OFF.
2	On the top front section of the Power Platform, release the two slide fasteners holding the cover in place by pressing them inward.
3	Remove the cover.
4	Gently lift the battery pack from the battery compartment and disconnect the battery pack connector from the unit's mating connector.
5	Remove battery pack.
6	Connect the replacement battery pack connector to the unit's mating connector and place the new pack into the compartment.
7	Replace the cover and press down until it latches closed.
8	Discard the old battery pack in accordance with Environmental Protection Agency (EPA) regulations.
9	Set the Power Platform's power switch to ON.
10	Allow 8 hours to ensure a full charge. The Power Platform can be operated normally, using AC power, during this time.

---

# Memory Card Battery Replacement

---

**Introduction** Replacement of the 3-volt lithium battery in the memory card is performed when the battery message in the Memory Card Function screen states the battery is depleted. Replacement is simple and requires no special tools. Two physically different types of batteries are used due to different manufacturers of the memory card. The correct replacement type must be used.

---

**WARNING** The battery used in this device may present a fire or chemical burn hazard if mistreated. Do not recharge, disassemble, or dispose of in fire. Replace battery with Panasonic BR2325 or CR2025 only. Use of another type battery may present a risk of fire or explosion.

---

**ADVERTENCIA** La batería empleada en este dispositivo puede presentar un peligro de incendio o quemadura química si se manipula indebidamente. No recargue, desarme ni deseche en el fuego. Cambie la batería por una Panasonic BR2325 o CR2025 solamente. El uso de cualquier otro tipo de batería puede presentar un peligro de incendio o explosión.

---

**AVERTISSEMENT** La batterie utilisée dans cette unité peut présenter des risques d'incendie ou de brûlures chimiques par suite d'une utilisation abusive. Ne pas recharger, démonter, ni jeter au feu. Remplacer uniquement la batterie par une batterie Panasonic BR2325 ou CR2025. L'utilisation d'un tout autre modèle de batterie peut entraîner des risques d'incendie ou d'explosion.

---

**WARNUNG** Die in diesem Gerät verwendete Batterie kann im Falle einer unsachgemäßen Behandlung zu Bränden oder chemischen Verätzungen führen. Sie sollte nicht wiederaufgeladen, auseinandergenommen oder verbrannt werden. Ersetzen Sie die Batterie nur mit Batterien vom Typ Panasonic BR2325 oder CR2025. Die Verwendung eines anderen Batterietyps kann Brände oder Explosionen hervorrufen.

---

*Continued on next page*

## Memory Card Battery Replacement, Continued

**Battery check** To check the condition of the memory card battery, perform the following steps.

Step	Action
1	Insert questionable memory card in memory card slot on Power Platform and press card in firmly.
2	From Main Menu select 3, Setup Menu.
3	From Setup Menu select 7, Memory Functions.
4	From Memory Functions display select 1, Memory Card Functions.
5	Read Memory Card Battery = OK. If OK, do not replace the battery. If not OK, proceed to replacement procedure.
6	If message says OK, but the memory card is faulty, try a different memory card for operation. If the replacement memory card operates OK, the original memory card is faulty and should be replaced.

**Battery types** There are two types of physically different memory card batteries. Both batteries are 3-Volt, lithium, wafer type.

Part Number	Diameter	Thickness
Panasonic CR2025	0.79" (20mm)	0.1" (2.5mm)
Panasonic BR2325	0.9" (23mm)	0.1" (2.5mm)

**Battery Safety Precautions** The following safety precautions must be adhered to.

- Keep batteries away from children. Never permit a child to play with a battery as an ornament or toy.
- Do not disassemble battery or battery pack.
- Do not dispose of battery in fire.
- Dispose of a used battery promptly in accordance with local Environmental Protection Agency (EPA) regulations.

*Continued on next page*

## Memory Card Battery Replacement, Continued

---

### Medidas de seguridad de la batería

Deberán observarse las medidas de seguridad siguientes:

- No deberá mantenerse las baterías al alcance de los niños. No deberá permitirse que un niño juegue con una batería.
  - No deberá desensamblarse ninguna batería ni el compartimiento de la misma.
  - No deberá prenderse fuego a una batería.
  - Toda batería agotada deberá desecharse de manera rápida según las normas locales de la Agencia de protección del medio ambiente (EPA).
- 

### Mesures de sécurité relatives aux batteries

Il est très important de suivre les mesures de sécurité suivantes.

- Ne pas laisser les batteries à la portée des enfants. Ne jamais laisser un enfant jouer avec une batterie.
  - Ne pas démonter de batterie ou de bloc-batterie.
  - Ne pas jeter de batterie dans le feu.
  - Se débarrasser rapidement des batteries usagées en se conformant aux règlements de l'EPA (Agence américaine pour la protection de l'environnement).
- 

### Batterie-Sicherheitsvorkehrungen

Die folgenden Sicherheitsvorkehrungen müssen beachtet werden.

- Halten Sie Batterien von Kindern fern. Erlauben Sie einem Kind unter keinen Umständen, eine Batterie als Verzierung oder Spielzeug zu benutzen.
  - Nehmen Sie Batterien oder Batteriepackungen nicht auseinander.
  - Entsorgen Sie Batterien nicht durch Verbrennen.
  - Entsorgen Sie verbrauchte Batterien umgehend nach den gesetzlichen Umweltschutzbestimmungen.
- 

*Continued on next page*



## Memory Card Battery Replacement, Continued

### Replacement procedure

To remove and replace a memory card battery, proceed with the following steps.

Step	Action
1	Remove memory card from Power Platform.
2	Refer to figure below. Gently press in battery release with pencil point and remove battery holder
3	Remove battery from holder and identify the type battery used. If type is not identified on body of battery refer to preceding page for battery dimensions.
4	Insert the exact type replacement battery in holder with plus (+) terminal facing up.
5	Insert battery holder into memory card and press in until locked in position.
6	Dispose of battery promptly. See safety precautions above.

### Battery replacement diagram (typical)

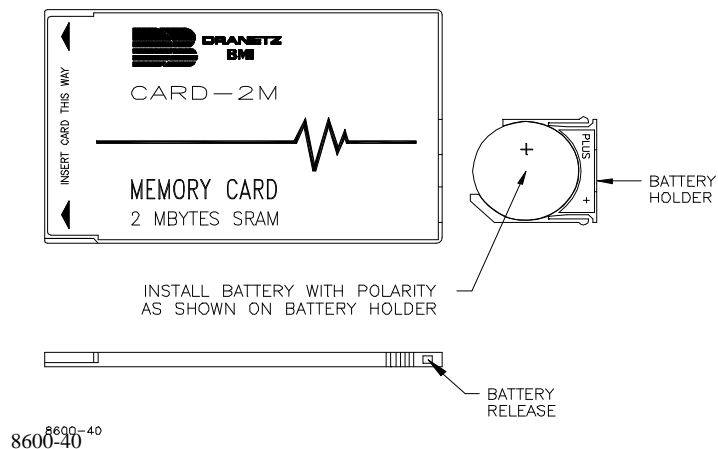



# Appendix D

## Fuse Replacement

### Overview

---

**Introduction** Operator replaceable fuses consist of the main power fuses and the battery fuse. One of each type replacement fuse is located in the battery compartment and all fuses are accessible from the rear panel. Both types of replacement are covered in this appendix.

---

**WARNING** For continued protection against risk of fire or shock replace only with the same type and rating of fuse.

---

**ADVERTENCIA** Para la protección continua contra el peligro de incendio o descarga, cambie sólo por fusibles del mismo tipo y capacidad nominal.

---

**AVERTISSEMENT** Pour assurer une protection continue contre les risques d'incendie ou de choc, ne remplacez que par un fusible du même type et de la même valeur nominale.

---

**WARNUNG** Zum anhaltenden Schutz gegen Brand oder einen elektrischen Schlag nur gegen eine Sicherung desselben Typs und mit demselben Nennwert austauschen.

---

**In this appendix** The following topics are covered in this appendix.

Topic	See Page
Main Power Fuses	D-2
Battery Fuse	D-5

---

## Main Power Fuses

### Main Power Fuses

Follow these steps to remove and replace the two main power fuses. Refer to the diagram on the following page.

Step	Action
1	Set the Power Platform's power switch to OFF.
2	Turn off all power to monitoring circuits. Disconnect all Power Platform monitoring cables from power sources.
3	Disconnect the power cord plug from its wall or power receptacle, then remove the power cord from the AC power input module on the rear panel.
4	Place a small screwdriver blade into the notch next to the release arm of the fuse drawer.
5	Push the release to the right and pivot the screwdriver to the left to release the fuse drawer.
6	Remove the fuse drawer by pulling it straight out of the housing.
7	Replace blown fuse(s) with the exact replacement of slow-blow (time-delayed) fuse(s). See Main Power Fuse table.
8	Insert fuse drawer and press in until it snaps into position.
9	Reconnect power cord to the AC power input module, then reconnect power cord plug to its wall or power receptacle.
10	Before powering the unit on, refer to Chapter 4, Section A for operating precautions.
11	Set the Power Platform's power switch to ON.
12	Verify that the unit is operational.

### WARNING

**Do not replace fuse again if failure is repeated. Repeated failure indicates a defective condition that will not clear with replacement of the fuse. Refer condition to a qualified technician.**

### ADVERTENCIA

**No reemplace el fusible nuevamente si se repite la falla. La repetición de las fallas indica una condición defectuosa que no se subsanará con el cambio del fusible. Acuda a un técnico calificado para evaluar la condición.**

*Continued on next page*

## Main Power Fuses, Continued

---

**AVERTISSE-  
MENT**

**Ne remplacez pas le fusible une nouvelle fois si la défaillance se répète. Une défaillance répétée indique une condition défectueuse qui ne disparaîtra pas avec le remplacement du fusible. Consultez un technicien qualifié.**

---

**WARNUNG**

**Die Sicherung nicht erneut austauschen, wenn der Fehler noch einmal auftritt. Ein wiederholtes Auftreten des Fehlers weist auf einen Defekt hin, der sich nicht durch Austauschen der Sicherung beheben läßt. Den Defekt einem qualifizierten Techniker mitteilen.**

---

**Main Power  
Fuse table**

Use this table to determine the type of fuse required.

	<b>Main Power Fuse</b>	<b>Dranetz-BMI P/N</b>
Model PP1	Slow blow, 250V, T2A, 3AG, glass tube 1/4 x 1 1/4	113204-G2
Model PP1E	Slow blow, 250V, T1.25A glass tube 5 x 20 mm (standard IEC127, type T, sheet III)	900387

---

*Continued on next page*

# Main Power Fuses, Continued

---

## Diagram

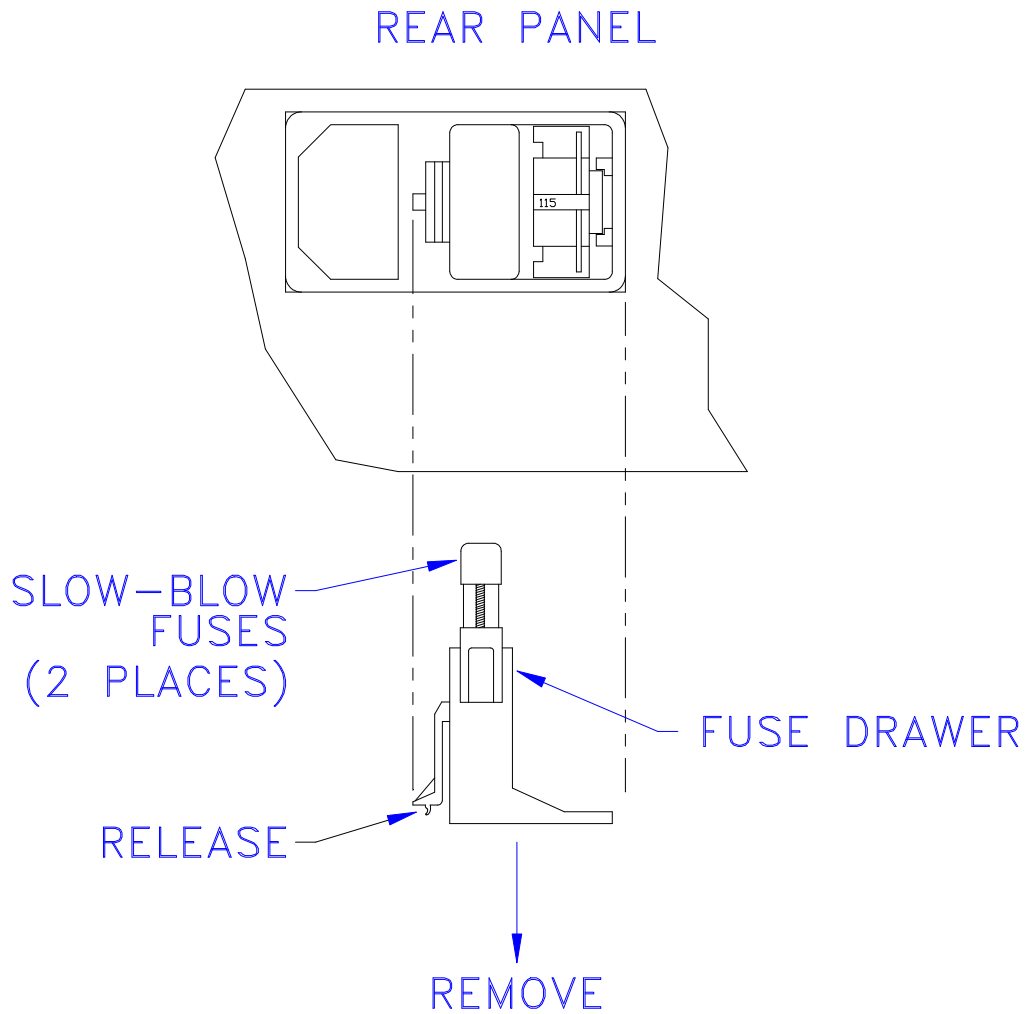

# Battery Fuse

---

**Introduction** The battery fuse is used for fusing the internal battery pack, as well as an external DC source that is connected to the DC power source jack on the rear of the unit.

---

**Procedure** Follow these steps to replace the battery fuse.

Step	Action
1	Set the Power Platform's power switch to OFF.
2	Turn off all power to monitoring circuits. Disconnect all Power Platform monitoring cables from power sources.
3	If external DC source is being used, disconnect it or turn it off. If using an external DC battery, disconnect the negative terminal and then the positive terminal.
4	Disconnect external DC power source plug from external DC power source input jack on the rear panel of the Power Platform.
5	Insert the blade of a small screwdriver into the slot on the fuse cap and rotate a quarter turn counter clockwise.
6	Test fuse for continuity with an ohmmeter and replace fuse if blown. Replace blown fuse with the exact replacement of slow-blow (time delayed) fuse. See Battery Fuse table.
7	Reinsert the fuse cap and tighten securely.
8	Reconnect external DC source (if external DC source is being used).
9	Before powering the unit on, refer to Chapter 4, Section A for correct operating precautions.
10	Set the Power Platform's power switch to ON.

---

**WARNING** Do not replace fuse again if failure is repeated. Repeated failure indicates a defective condition that will not clear with replacement of the fuse. Refer condition to a qualified technician.

---

**ADVERTENCIA** No reemplace el fusible nuevamente si se repite la falla. La repetición de las fallas indica una condición defectuosa que no se subsanará con el cambio del fusible. Acuda a un técnico calificado para evaluar la condición.

---

*Continued on next page*

## Battery Fuse, Continued

---

**AVERTISSE-  
MENT**

**Ne remplacez pas le fusible une nouvelle fois si la défaillance se répète. Une défaillance répétée indique une condition défectueuse qui ne disparaîtra pas avec le remplacement du fusible. Consultez un technicien qualifié.**

---

**WARNUNG**

**Die Sicherung nicht erneut austauschen, wenn der Fehler noch einmal auftritt. Ein wiederholtes Auftreten des Fehlers weist auf einen Defekt hin, der sich nicht durch Austauschen der Sicherung beheben läßt. Den Defekt einem qualifizierten Techniker mitteilen.**

---

**Battery Fuse  
table**

Use this table to determine the type of fuse required.

	<b>Main Power Fuse</b>	<b>Dranetz-BMI P/N</b>
Model PP1	Slow blow, 250V, T10A, 3AB, ceramic tube 1/4 x 1 1/4	113204-G3
Model PP1E	Slow blow, 250V, T6.3A glass tube 5 x 20 mm (standard IEC127, type T, sheet III)	900396

---



## Appendix E

### Operator Replaceable Parts List

---

**Introduction**      The following parts are listed for those items readily replaceable by the operator and not requiring special tools or access to the interior of the unit.

---

**To order parts**      Call Dranetz-BMI Customer Service to order any of the following parts, telephone 1-800-372-6832 or 732-287-3680.

---

**Parts List**

Part Description	Part Number
Rubber Foot (Rear Panel)	115284-G1
Screw for above, 6-32 x 5/8" Long	113200-G15
Keylock keys (2)	115282-G1
Label, RUN/LOAD	115117-G1
Fuse, Slow blow, 250V, T2A, 3AG, glass tube 1/4 x 1 1/4 (AC power input) for PP1	113204-G2
Fuse, Slow blow, 250V, T1.25A glass tube 5 x 20 mm (standard IEC127, type T, sheet III) (AC power input) for PP1E	900387
Fuse, Slow blow, 250V, T10A, 3AB, ceramic tube 1/4 x 1 1/4 (Internal/External Battery) for PP1	113204-G3
Fuse, Slow blow, 250V, T6.3A glass tube 5 x 20 mm (standard IEC127, type T, sheet III) (Internal/External Battery) for PP1E	900396
Battery Pack	FBP-8
Battery Cover, without latches	115110-G1
Latch for Battery Cover (2 req'd)	115341-G1
Rubber Foot (Display Assembly)	113304-G1
Measurement Cable Set, complete (See next page for separate parts.)	115815-G1

---

*Continued on next page*

## Parts List, Continued

### Measurement Cable Set, Parts List

Part Description	Part Number		
	Domestic	Euro	UK
Measurement Cable Set	115815-G1	115815-G2	115815-G3
Cable Pallet	115816-G1	115816-G1	115816-G1
Interconnecting Cable Assy, Blue, 12 in. (30.5 cm)	114013-G1	114013-G1	114013-G1
Interconnecting Cable Assy, Red, 96 in. (243.8 cm)	114013-G2	114013-G2	114013-G2
Interconnecting Cable Assy, Black, 96 in. (243.8 cm)	114013-G3	114013-G3	114013-G3
Interconnecting Cable Assy, Blue, 96 in. (243.8 cm)	114013-G4	114013-G4	114013-G4
Interconnecting Cable Assy, Yellow, 96 in. (243.8 cm)	114013-G5	114013-G5	114013-G5
Safety Ground Cable Assy	114014-G5	114014-G5	114014-G5
Safety Clip Set Assy (Consists of 1 red and 1 black safety clip with attached caution label)	114890-G1	114890-G1	114890-G1
Power Cord, shielded, 115 VAC (Domestic)	110893-G1		
Power Cord, Shielded, 230 VAC (Euro)		115369-G1	
Power Cord, Shielded, 230 VAC (UK)			115368-G2

# Appendix F

## Technical Specifications

### Overview

---

**In this appendix** The following specifications are covered in this appendix.

<b>Topic</b>	<b>See Page</b>
General	F-2
Interfaces	F-3
Measured Parameters	F-5
Computed Parameters	F-7
Current Probes	F-9
Isolated Current Transformer Boxes	F-10

---

## General

---

<b>Dimensions</b>	<u>Size:</u> 7” Height x 13” Width x 10” Depth (17.8 x 33 x 25.4 cm) <u>Weight:</u> 20.8 pounds (9.4 kg)
<b>Environmental</b>	<u>Operating:</u> 5 to 45° Celsius (41 to 113° F) <u>Storage:</u> -20 to 55° Celsius (-4 to 131° F). <u>Humidity:</u> 10% to 90% non-condensing.
<b>System Time Clock</b>	Crystal controlled. 1 second resolution. Event time clock displays to 10msec resolution time displayed in 24 hour format HH:MM:SS. Accurate to 60 seconds per month.
<b>Memory</b>	750 kbytes of standard non-volatile data RAM (event storage). 256 kbytes of standard volatile data RAM (system memory). 768 kbytes of program RAM. (system memory) 256 kbytes of program EPROM. (system memory)
<b>Memory Card</b>	512Kbytes to 2Mbytes depending on the optional card memory capacity.
<b>Note</b>	A 15 minute warm up period is required to ensure that all performance specifications are met.
<b>Power Requirements</b>	<u>Voltage:</u> Switch selectable 90-130 or 180-250 V RMS. <u>Frequency:</u> 47-450 Hz. <u>Consumption:</u> 100 watts max.  Unit will also operate using a 12 Vdc, 10 A external battery with filtering.
<b>Installation Categories</b>	<u>Mains supply:</u> Installation Category II, Pollution Degree 2 <u>Measurement inputs:</u> Installation Category III, Pollution Degree 2

---

## Interfaces

---

### Display

Type: Negative Transmissive Liquid Crystal Display (LCD) with Electroluminescent (EL) backlighting.

Resolution: 240 x 128 dot matrix.

Size: 4.25 x 2.27 inches.

---

### Printer

Type: High resolution thermal graphics printer.

Resolution: 320 dots per line.

Speed: 1 inch per second.

Paper: 2.36 inches by 98 feet thermal paper.

Report size: Approximately 4 inches wide.

---

### Serial Port

One RS232D female 25-pin D-type connector.

Configuration: DCE

Data rate: 300 to 9600 baud

Stop bits: 1

Parity: Odd, even, or none

---

### Internal Modem/Fax:

Compatible with: Bell 103, Bell 212A, V.22, V.22 bis Responds to "AT" command set, FAX is group III compatible.

Modem data rate: 300, 1200, 2400 baud (automatic)

Fax data rate: 9600

Phone jack (USOC): RJ-11C

---

*Continued on next page*

## Interfaces, Continued

---

**Internal  
Modem/Fax:**  
(continued)

FCC registration: B46USA-65156-FA-E

Ringer equivalence: 0.2 A

---

**Relay outputs**

One relay for external access rated 120 V AC or 30 V DC at 1 amp max. Rated as pilot relay.

---

**Alarm**

Audible alarm of short duration (approximately 0.1 second) indicates an error condition. Audible alarm of long duration (approximately 1 second) indicates an event trigger.

---

## Measured Parameters

---

### Voltage

Four fully differential voltage channels.

Channels A,B,C range: 10-600 Vrms max

Channel D low range: 1-60 Vrms max

Channel D high range: 10-600 Vrms max

Crest factor: Maximum of 2 at full scale

Accuracy:  $\pm 0.5\%$  of reading  $\pm 0.05\%$  full scale

---

### Voltage transients

Channels A,B,C range: 50-6000 Vpk

Channel D low range: 5-600 Vpk

Channel D high range: 50-6000 Vpk

Frequency response: Typically -4dB at 1 $\mu$ s for half sine wave pulse

Accuracy:  $\pm 10\%$  of reading  $\pm 1\%$  full scale for half sine wave pulses  $\geq 10\mu$ s

Transient duration: 1  $\mu$ sec minimum

---

### Current

Four independent current input channels.

Channels A,B, C range: 10%-200% of full scale CT rating

Channel D range: 2%-100% of full scale CT rating

Channels A,B,C crest factor: Maximum of 3 at full scale

Channel D crest factor: Maximum of 2 at full scale

Accuracy:  $\pm 0.5\%$  of reading  $\pm 0.05\%$  of full scale, at fundamental frequency, using Dranetz-BMI CT-10, CT-150, CT-300, CT-1000, CT-3000 probes only.

---

*Continued on next page*

## Measured Parameters, Continued

---

### Current transients

Channels A,B,C range: 10%-300% CT full scale

Channel D range: 2%-200% CT full scale

Frequency Response: Typically -4dB at 1 $\mu$ s for half sine wave pulses plus probe.

Accuracy:  $\pm 10\%$  of reading  $\pm 1\%$  FS for half sine wave pulses  $\geq 10\mu$ s plus probe.

Transient Duration: 1  $\mu$ sec minimum

---

### Phase

Each voltage/current pair (i.e. Channel A voltage, Channel A current) are sampled simultaneously to preserve phase relationship.

---

### Input resistance

Voltage input: 8 Mohms

Current input: 200 kohms

---

### Frequency

Fundamental range: 30Hz - 450Hz

Accuracy:  $\pm 0.2\%$  of reading

---

### Environmental

All specifications are met at 25 degrees Celsius (77° F)

Temperature coefficient for measured parameters is approximately 200 ppm of full scale per degree Celsius.

---



## Computed Parameters

---

**Update rate** All parameters (except harmonic) are updated once per second. Harmonic based parameters are updated every 5 seconds.

---

**ABC volts** Calculated as the geometric mean of the three phases. See note.

$$V_{ABC} = \sqrt{(V_A^2 + V_B^2 + V_C^2)/3}$$

---

**ABC amps** Calculated as the sum of the three phases. See note.

$$I_{ABC} = I_A + I_B + I_C$$

---

**Real power** Single Phase: Average of instantaneous power samples taken as the product of voltage and current samples. Includes sign to indicate direction of power flow: + from source to load, - from load to source.

$$W = (1/N) \sum_{n=1}^N V_n I_n$$

Three Phase: Calculated as the sum of the three phases. Includes sign to indicate direction of power flow: + from source to load, - from load to source. See note.

$$W_{ABC} = W_A + W_B + W_C$$

Accuracy:  $\pm 2\%$  of reading  $\pm 0.2\%$  of full scale at fundamental frequency.

---

**Note** All totals (ABC) numbers are not 3 phase. They are based on the wiring configuration, which can have single phase, split phase, wye or delta phase. Totals are based on N phases for calculations.

---

*Continued on next page*

## Computed Parameters, Continued

---

**Apparent power** Single Phase: Calculated as volts RMS times amps RMS.

$$VA = V_{rms} \cdot I_{rms}$$

Three Phase: Calculated as vector sum of  $VAR_{ABC}$  and  $W_{ABC}$ . Includes sign to indicate direction of power flow: + from source to load, - from load to source.

$$VA_{ABC} = \sqrt{VAR_{ABC}^2 + W_{ABC}^2}$$

Accuracy:  $\pm 2\%$  of reading  $\pm 0.2\%$  of full scale at fundamental frequency.

---

**Power factor** Calculated as real power divided by apparent power. Includes sign to indicate leading or lagging load current.

$$PF = W/VA$$

Accuracy:  $\pm 0.05$  typical

---

**Reactive power** Single Phase: Calculated as vector difference between VA and W. Includes sign to indicate direction of power flow: + from source to load, - from load to source.

$$VAR = \sqrt{(VA)^2 - W^2}$$

Three Phase: Calculated as the sum of the three phases. Includes sign to indicate direction.

$$VAR_{ABC} = VAR_A + VAR_B + VAR_C$$

Accuracy:  $\pm 2\%$  of reading,  $\pm 0.2\%$  of full scale at power factor = 1.

---

**Environmental** All specifications are met at 25 degrees Celsius.

Temperature coefficient for computed parameters is approximately 400 ppm of full scale per degree Celsius.

---

# Current Probes

- Guidelines** To achieve the rated accuracies, follow these guidelines:
- The conductor must be at a right angle to the probe
  - The conductor must be centered in the probe core
  - The jaw contact surfaces must be clean and properly aligned.

**Specifications** The following table lists the operating specifications for all optional Dranetz-BMI current probes.

	<b>CT10</b>	<b>CT150</b>	<b>CT300</b>	<b>CT1000</b>	<b>CT3000</b>
Current Range for Amplitude Accuracy (Arms) of 0.5%	1 to 10	3 to 125	10 to 300	50 to 1000	200 to 3000
Current Range for Phase Accuracy of 0.2° (Arms) at Calibration Point ( )	2 to 10 (5)	5 to 125 (30)	15 to 300 (200)	100 to 1000 (200)	300 to 3000 (300)
Frequency Range (Hz)	45 to 10,000	45 to 10,000	15 to 10,000	30 to 50,000	30 to 5000
Impulse Width	Typically -3dB at 1 µsec at one-half sine wave.				
Output Signal of 3 Vrms at	10 Arms	150 Arms	300 Arms	1000 Arms	3000 Arms
Maximum Conductor Size	0.47" (12mm)	0.47" (12mm)	2.13" (54mm)	2.17" (55mm)	2.56" (65mm) or 1.97" x 5.3" (50 x 135 mm) or 2.56" x 3.94" (65 x 100 mm)

**Environmental** Operation: 5 to 45 degrees Celsius (41 to 113° F)

Storage: -20 to 55 degrees Celsius (-4 to 131° F)

## Isolated Current Transformer Boxes

---

**Specifications** The following tables list the operating specifications for Dranetz-BMI isolated current transformers.

	<b>ISO-1</b>	<b>ISO-1A</b>	<b>ISO-5</b>
Current Range (Arms)	0.02 to 1.0 2.0 Arms max	0.02 to 1.0 2.0 Arms max	0.10 to 5.0 10.0 Arms max
Frequency Response (Hz)	50 to 3000	50 to 3000	50 to 3000
Output signal	3 Vrms @1 Arms	2 Vrms @ 1 Arms	3 Vrms @ 5 Arms
Accuracy	±1% 0.2 to 1 Arms	±1% 0.2 to 1 Arms	±1% 0.5 to 5 Arms
Scale Factor	0.333	0.500	1.666

---

**Environmental** Operation: 5 to 45 degrees Celsius (41 to 113° F)

Storage: -20 to 55 degrees Celsius (-4 to 131° F)

---

# Appendix G

## PP1-Inrush Messages

### Overview

---

**Introduction** PP1-Inrush messages provide you with information or tell you about an error. This appendix describes the types of messages that can appear, lists the messages, and gives instructions about what to do next. Self-explanatory messages are not included.

---

**In this appendix** The following topics are covered in this appendix.

Topic	See Page
Message Types	G-2
Messages	G-3

---

# Message Types

---

## Introduction

There are three types of messages: Normal One-Line, Important One-Line, and Full Screen. When a message is displayed it is automatically saved to memory for recall at a later time.

---

## One-line messages

All one-line messages are displayed on the top line of the screen between the time and date, and are a maximum of 21 characters long. They are displayed as long as the condition exists.

Normal one-line messages: Normal one-line messages are displayed in regular text.

Important one-line messages: Important one-line messages are displayed in reverse video.

---

## Full screen messages

Full screen messages warn you of potential system problems. You must press a key to remove the screen message.

---

## Priority

In general, a more important message will take priority over a less important one, with the exception of full screen messages which are displayed until you to press a key.

When two or more one-line message are active, they are cycled every two seconds. The priority is as follow:

Priority	Description
1	All new one-line messages are displayed immediately, accompanied by a short beep, then normal message cycling is resumed.
2	When there are important one-line messages, only these will be cycled until they are cleared.
3	When there is only one important one-line message displayed, no normal one-line messages will cycle until the displayed message is cleared.
4	No one-line messages are displayed on HELP screens, but full screen messages will operate normally.
5	Full screen messages will always take precedence over any type of one-line display.

---

# Messages

---

## One-line messages

### **Printer Head Overheat**

### **Internal Bat Low**

The charge on the internal battery is low. Plug the unit into an AC power source and turn on. Let charge for eight hours.

### **Internal Bat Bad**

Check the internal battery connection. If the condition continues, the battery may have to be replaced.

### **External Bat Bad**

Check the external battery charge and connections. Call Dranetz-BMI if the condition continues.

### **Sync Lost Ch A, B, C, or D**

The unit cannot synchronize to the specified channel. Either no voltage or a voltage outside the sync range is being applied. If the unit continues to switch between Sync Lost and Sync Acquired, you may have to change to internal sync.

### **Sync Acquired-Ch A, B, C, or D**

The unit has synchronized to the specified voltage channel.

### **Probe Ch A, B, C, or D-Connect**

A current probe has been connected to the specified channel.

### **Probe Ch A, B, C, or D-Disconnect**

The current probe on the specified channel has been disconnected.

### **Volts Overload Ch-A, B, C, or D**

The voltage range for the specified channel has been exceeded.

### **Amps Overload Ch-A, B, C, or D**

The current range for the specified channel has been exceeded. Use a probe with a range appropriate for your measurements.

### **Volts Overrange Ch A, B, C, or D**

The voltage safety limit for the specified channel has been exceeded. Turn off power to the circuit and disconnect the unit.

---

*Continued on next page*

## Messages, Continued

---

### One-line messages (continued)

#### **Amps Overrange Ch A, B, C, or D**

The current safety limit for the specified channel has been exceeded. Turn off power to circuit and disconnect the unit.

#### **AC Power Lost**

The unit has now switched to battery power.

#### **AC Power Restored**

AC power has been restored and the unit is no longer operating from battery.

---

### Full screen messages

#### **Printer Power Failure**

All print operations are currently suspended, please call Dranetz-BMI for service.

#### **AC Power Lost**

The unit has now switched to battery operation.

#### **ACP Self Reset**

The ACP processor has reset. If this occurs regularly, please call Dranetz-BMI for service.

---



## Appendix H

### Connecting an External DC Power Supply

#### Overview

---

**Introduction** An external DC source of power can be connected to the Power Platform for normal operation without having to rely on local AC power. An external stand-alone automotive battery (installed in or out of the vehicle) or a regulated DC power supply of at least 10 amps capacity may be used. Connection is made to the DC external source jack in the lower left corner of the rear panel.

---

**WARNING** **Physical injury or damage to the instrument could result from incorrect connections. Always observe correct polarity. Make connections to the PP1 first and then make connections to the external DC power source.**

---

**ADVERTENCIA** **Podrían producirse lesiones físicas o daños al instrumento debido a conexiones incorrectas. Siempre observe la polaridad correcta. Efectúe primero las conexiones al PP1 y luego haga las conexiones a la fuente de energía de corriente continua externa.**

---

**AVERTISSEMENT** **Des connexions incorrectes risquent de causer des blessures aux personnes ou l'endommagement du matériel. Observez toujours la polarité correcte. Faites les connexions au PP1 en premier, puis branchez sur la source d'alimentation c.c. externe.**

---

**WARNUNG** **Falsche Verbindungen können zu Verletzungen oder Schäden am Gerät führen. Immer auf richtige Polarität achten. Zuerst Anschlüsse mit dem PP1 und dann Anschlüsse mit der externen Gleichspannungsquelle vornehmen.**

---

**CAUTION** **The internal battery of the Power Platform must be installed and charged before connecting an external power source to prevent possible damage to the Power Platform and/or the external power source.**

---

*Continued on next page*

## Overview, Continued

---

**PRECAUTION** Debe estar instalada y cargada la batería interna del PP1 antes de conectar a una fuente de energía externa, a fin de prevenir posibles daños al PP1 y a la fuente de energía externa. Si se desconoce la condición cargada de la batería interna, cargue la batería por lo menos durante 16 horas.

---

**MISE EN GARDE** La batterie interne du PP1 doit être installée et chargée avant toute connexion à une source d'alimentation externe afin d'éviter tout risque d'endommagement du PP1 et de la source d'alimentation externe. Si l'état de charge de la batterie interne n'est pas connu, chargez la batterie pendant un minimum de 16 heures.

---

**VORSICHT** Zur Vermeidung möglicher Schäden am PP1 und der externen Spannungsquelle muß die interne Batterie des PP1 vor dem Anschluß an eine externe Spannungsquelle installiert und aufgeladen werden. Ist der Ladezustand der internen Batterie nicht bekannt, die Batterie mindestens 16 Stunden lang aufladen.

---

**Standard Accessory** A DC connector, part number 107506, is supplied with the Power Platform to permit you to make your own external power connecting cable.

---

**Optional Accessories** Optional connecting cables and a DC filter are available as accessories to connect external DC sources.

---

**In this appendix** The following topics are covered in this appendix.

Topic	See Page
Making and Connecting the DC Input Cable	H-3
External Battery Filter	H-6
Extension Cables	H-7
Installing the Battery Filter	H-8

## Making and Connecting the DC Input Cable

---

### Description

A connector plug is supplied with the Power Platform for making a cable for connection to a stand alone battery or DC supply.

Connection to Power Platform: External DC power source jack (10-16V) on the rear panel

Maximum cable length: 6 feet

Minimum wire size: 16 AWG

---

### Connector plug

Below is the diagram of the connector plug (P/N 107506) supplied as a standard accessory of the Power Platform.

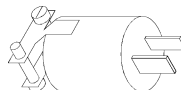

8000-15

---

### Restrictions

If the cable will be longer than 6 feet, or if the internal battery is to be connected to any other device (including a charging system), use the optional battery filter (Option XBF-12) and recommended optional cables. See page C-3.

---

### Making the DC cable

Follow these guidelines when making the DC cable.

- Connect a 16 AWG black colored wire (6 feet max) to pin 1 (wide prong) of connector plug. This is the negative (-) terminal.
  - Connect a 16 AWG red colored wire (6 feet max) to pin 2 of the connector plug. This is the positive (+) terminal.
- 

### WARNING

**Physical injury, or equipment damage could result if the cable is wired incorrectly. Verify all connections are correct before proceeding.**

---

### ADVERTENCIA

**Podrían producirse lesiones físicas o daños al equipo si se conecta incorrectamente el cable. Compruebe que todas las conexiones estén correctas antes de proceder.**

---

*Continued on next page*

## Making and Connecting the DC Input Cable, Continued

**AVERTISSEMENT** Une connexion incorrecte du câble risque de causer des blessures aux personnes ou l'endommagement du matériel. Vérifiez que toutes les connexions sont correctes avant de poursuivre.

**WARNUNG** Bei einem falschen Anschluß des Kabels kann es zu Verletzungen oder Schäden am Gerät kommen. Vor dem Fortfahren überprüfen, ob alle Anschlüsse ordnungsgemäß vorgenommen wurden.

**Internal battery check** Follow these steps to check the status of the internal battery before connecting an external DC source.

Step	Action
1	From the Main Menu, select item 5, View Status
2	Press ANLYZR STATUS.  <u>Result:</u> A screen similar to the following will appear. <div data-bbox="673 993 1295 1331" data-label="Code-Block"><pre>Jan-20-94 13:24:29 ANALYZER STATUS DISPLAY PRINTER: ON          CONFIG: V1.0 RS232: OFF          BATTERY: GOOD MODEM: OFF          INPUT: GOOD MEMORY: 1024k ON HOST CPU: V2.0 GOOD I/O CPU: V1.0 GOOD ACP CPU: V1.0 GOOD DATABASE: V2.0 PRINT EXIT</pre></div>
3	Verify that the Battery=Good statement is displayed.

**CAUTION** Do not connect an external DC source if the battery statement is other than GOOD. Determine cause of battery fault before continuing.

**PRECAUCION** No conecte una fuente de CC externa si el estado de la batería no es GOOD (BUENO). Determine la causa de la falla de la batería antes de continuar.

*Continued on next page*

## Making and Connecting the DC Input Cable, Continued

---

**MISE EN GARDE**

Ne pas connecter une source d'alimentation c.c. si l'état affiché de la batterie n'est pas **GOOD (BON)**. Il est important de déterminer pourquoi la batterie est faible avant de continuer.

---

**VORSICHT**

Schließen Sie keine externe DC-Stromversorgungsquelle an, wenn der Zustand der Batterie anders als "GOOD" (Gut) ist. Bestimmen Sie die Ursache des Batteriefehlers, bevor Sie fortfahren.

---

**Connecting the cable**

Follow these steps when connecting the DC cable to the Power Platform.

Step	Action
1	Turn off power to Power Platform.
2	Turn off power to the external power source.
3	Disconnect cable wires from battery terminals, if connected.
4	Connect plug of DC cable to Power Platform 10-16V external power input jack on rear panel.
5	Connect DC cable wires to external power source (battery or power supply).
6	Turn on external power supply, if connected.
7	Turn on power to the Power Platform.

---

# External Battery Filter

---

## Introduction

Battery Filter, Model XBF-12, hereinafter referred to as the filter, provides external DC filtering for an external power source connected to the Power Platform. The filter provides a filtered DC input to the external power input jack on the Power Platform. The filter suppresses automotive ignition noise and discriminates against voltage transients greater than 18 VDC peak.

---

## External power source

The external power source can consist of a 12V stand-alone battery or charging circuit of 12-16 VDC. If an automotive battery is used, it is recommended that the automotive engine be operating so that the battery is charging during usage.

---

## If using own cable

If using the battery filter with your own cable, maximum cable length cannot exceed 25 feet. The minimum wire size to use is 16 AWG. Use black colored wire to connect to the negative terminal on the battery filter. Use red colored wire to connect to the positive terminal.

---

## Filter description

The filter, Model XBF-12, shown below, consists of a two-terminal enclosure connected to an eight inch cable assembly, which is terminated by a two-pin plug. The two-pin polarized plug is connected to the rear panel connector jack, labeled 10-16VDC, on the Power Platform. Polarity indicators are provided on the cover for the terminal connections.

---

## Filter diagram

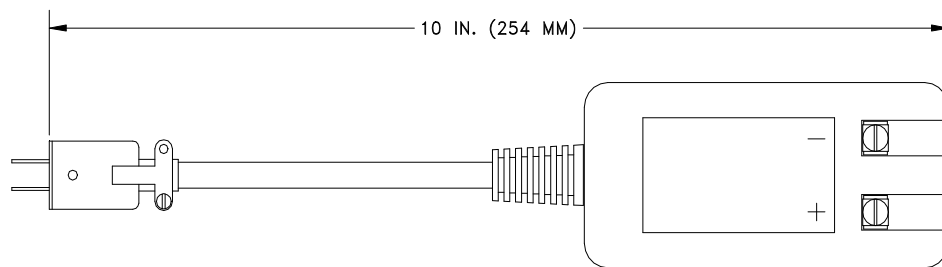

8600-32

---

# Extension Cables

## Introduction

Two types of accessory extension cables, shown below, permit connection of the filter to either an automotive cigarette lighter jack (also referred to as an accessory outlet) or to the terminal posts of a stand-alone battery. Both cables are 24 feet (7.3M) long and have spade lugs for connection of the two wires to the filter assembly terminals (+ Red, - Black).

## Lighter cable description

The lighter cable assembly plug contains an internal 7 amperes slow blow fuse to protect the automotive circuitry.

## Lighter cable diagram

The battery extension lighter cable assembly, P/N 115586-G1, is shown below.

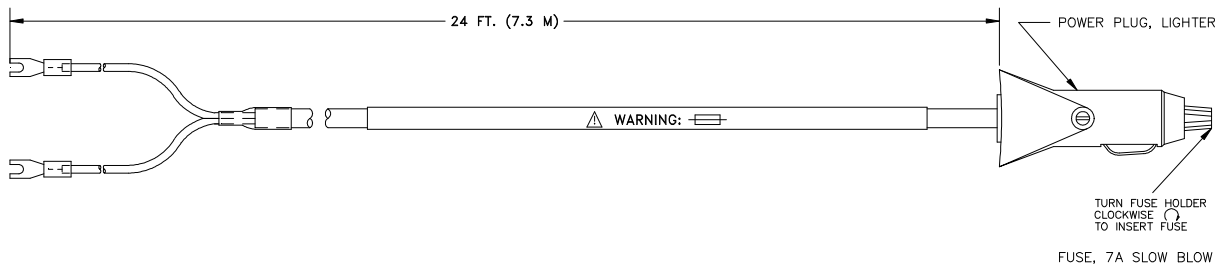

8600-33

## Clip cable description

The clip cable assembly provides direct connection to the battery with crocodile clips and contains a 10 amp slow blow fuse in an in-line fuse holder of the red lead.

## Clip cable diagram

The battery extension clip cable assembly, P/N 115587-G1, is shown below.

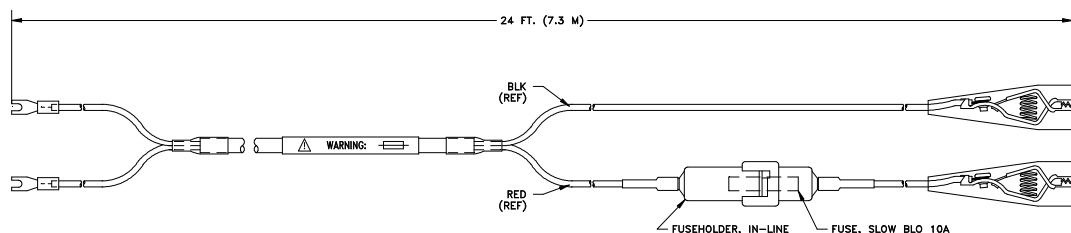

8600-34

## Installing the Battery Filter

---

**Before you begin** Before you install the filter, perform the internal battery check that is detailed on page H-4.

---

**Connect cable assembly to filter** Follow these steps to connect either cable assembly to the filter.

Step	Action
1	Turn off the Power Platform and disconnect the AC input power plug from the rear panel input connector.
2	Select the type of extension cable to use depending on the voltage source.  <u>Note:</u> Do not connect extension cable to source at this time.
3	Connect the extension cable spade lugs to the Filter assembly terminal connections. Red wire lug to plus (+) terminal and Black wire lug to negative (-) terminal.

---

**CAUTION** **Damage to the Power Platform and/or the external power source may occur if the lugs are reversed. Verify the proper color wires are connected to the correct polarity terminals; red wire to positive (+), black wire to negative (-).**

---

**PRECAUCION** **Pueden ocurrir daños a la Plataforma de energía y/o a la fuente de energía externa si se invierten las patas. Verifique si están conectados los alambres de color correcto a los terminales de la polaridad correcta; alambre rojo a positivo (+), alambre negro a negativo (-).**

---

**MISE EN GARDE** **L'inversion des languettes peut endommager la plate-forme d'alimentation et/ou la source d'alimentation externe. Assurez-vous que les fils de couleur sont connectés aux bornes appropriées ; le fil rouge sur le positif (+) et le fil noir sur le négatif (-).**

---

**VORSICHT** **Beschädigung an der "Power Platform" und/oder der externen Stromversorgungsquelle kann auftreten, wenn die Drähte vertauscht werden. Prüfen Sie die Farben der Drähte und ob diese an den richtigen Polaritäts-Terminals angeschlossen sind; roter Draht an Positiv (+), schwarzer Draht an Negativ (-).**

---

*Continued on next page*



## Installing the Battery Filter, Continued

---

**Connecting filter to Power Platform**      Connect polarized plug of the filter assembly into Power Platform rear panel jack (10-16 VDC).

---

**CAUTION**      **Before connecting or disconnecting directly to a stand-alone battery, place a damp cloth over the battery cell vent holes.**

---

**PRECAUCION**      **Antes de conectar o desconectar directamente a una batería autónoma, coloque un paño húmedo sobre el agujero de ventilación de la célula de la batería.**

---

**MISE EN GARDE**      **Avant la connexion ou la déconnexion directe d'une batterie autonome, placez un linge humide sur les orifices de ventilation de l'élément de batterie.**

---

**VORSICHT**      **Legen Sie vor dem Anschluß oder Abklemmen direkt an eine "Stand-Alone"-Batterie einen feuchten Lappen über die Batteriezellen-Ventilationslöcher.**

---

**Connecting cable to external DC power source**

Step	Action
1	If vehicle mounted battery is being used, turn off vehicle ignition.
2	If clip cable is used, go to step 3. If cigarette lighter plug cable is used, go to step 5.
3	Connect the positive (+) red clip to the positive (+) battery terminal.
4	Connect the negative (-) black clip to a negative common connection other than directly to the battery terminal.
5	Connect the cigarette lighter plug to vehicle lighter jack. The external source can be in its normal charging operation after connection (for instance; the automotive engine may be running).
6	(Optional) Replace ac power plug to Power Platform power input jack if ac power is available.
7	Turn on vehicle ignition and start engine, if vehicle battery is being used.

---

*Continued on next page*

## Installing the Battery Filter, Continued

---

### Disconnecting cables

Follow these steps when disconnecting an external DC power source.

Step	Action
1	Shut off power to Power Platform.
2	Turn off ignition at vehicle or disconnect power source connectors at power source.
3	Disconnect plug from DC input on Power Platform.
4	Return to normal Power Platform operation.

---

# Appendix I

## Inrush TASKCard Menu Structure

---

### Overview

The menu structure for the Inrush TASKCard is shown in the figure on the following page. The menu structure is shown with the Main Menu as being the leading element. This was done for sake of simplicity since the Main Menu is the originating menu for most menus once TASKCard operation begins. All other menus return to the Main Menu upon completion of their tasks. In actuality, following power up, the Scope Mode screen is the first display.

---



# Appendix J

## Internal Modem Commands

---

**General** The internal modem of the PP1 (not available in the PP1E) is a Hayes compatible modem used in Bell 212A or CCITT V.22 operation. The internal modem is controlled by default or operator selected serial command sequences entered as the Modem Header String during display of the Modem / Fax Configuration screen. The command line may be as long as 40 characters excluding command AT.

---

**Command codes** The Command Codes table, on the next page, lists the command codes with their descriptions.

---

**Note** It is not necessary to send the Command ATZ or AT&F because the PP1 automatically sends this command with every configuration.

---

**Register access codes** The Register Access Codes table, on page J-5, lists the registers accessed by the modem to execute a variety of operations. The function of each register is explained in the table. The value of each register must be 0-25

---

## Command Codes

---

Command	Description
AT	: Command line prefix (Attention code); precedes command line except ++++ (escape and A/ (repeat) commands
ATZ	: Loads the modem active configuration area with the stored configuration profile in nonvolatile memory
AT&F	: Loads the modem active configuration area with the factory profile contained in ROM
A	: Go off-hook in answer mode
A/	: Re-execute last command line; (A/ is not followed by a carriage return)
B	: Selects CCITT V.22 operation when communicating at 1200 bps
B1	: Selects Bell 212A operation when communicating at 1200 bps
D	: Dial number which follows D in the command line (See Dial Descriptors at end of table)
E	: Modem does not "echo" commands back to terminal
E1	: Modem "echoes" commands back to terminal
H	: On Hook (Hang up)
H1	: Off Hook
I	: Request product identification Code
I1	: Performs checksum on firmware ROM; returns checksum
I2	: Performs checksum on firmware ROM; returns OK or ERROR
L, L1	: Low speaker volume
L2	: Medium speaker volume
L3	: High Speaker Volume
M	: Speaker off
M1	: Speaker on until carrier detected
M2	: Speaker always on
M3	: Speaker on until carrier detected except during dialing
O	: Return to on-line state
O1	: Return to on-line state and initiate equalizer retrain
Q	: Modem returns result codes

---

*Continued on next page*

## Command Codes, Continued

---

<b>Command</b>	<b>Description</b>
Q1	: Modem does not return result codes
Sr=n	: Set register r to value n
Sr?	: Request contents of register r
V	: Short form numeric result codes
V1	: Full word result codes
X	: CONNECT result code enabled
X1	: Modem blind dials; all CONNECT XXXX result codes enabled; busy signal not detected
X2	: Modem waits for dial tone before dialing; all CONNECT XXXX result codes enabled; busy signal not detected
X3	: Modem blind dials; all CONNECT XXXX result codes enabled; modem sends BUSY result code if busy signal detected
X4	: Modem waits for dial tone before dialing; all CONNECT XXXX result codes enabled; modem sends BUSY result code if busy signal detected
Y	: Long space disconnect disabled
Y1	: Long space disconnect enabled
+++	: The default escape code
&C	: DCD always ON
&C1	: DEC ON indicates presence of data carrier
&D	: Modem ignores DTR
&D1	: Modem assumes command state when ON-to-OFF transition detected on DTR
&D2	: Modem hangs up, assumes command state and disables auto answer upon detected in ON-to-OFF transition on DTR
&D3	: Modem assumes initialization state upon detecting an ON-to-OFF transition on DTR
&G	: No guard tone
&G1	: 550 Hz guard tone
&G2	: 1800 Hz guard tone
&L	: Selects dialup (switched) line
&L1	: Selects leased line

---

*Continued on next page*

## Command Codes, Continued

---

<b>Command</b>	<b>Description</b>
&M3	: Synchronous mode 3 (DTR control of Data/Talk)
&P	: Pulse dial make/break ratio = 39/61 (USA)
&M	: Asynchronous mode
&M1	: Synchronous mode 1 (Sync/Async mode)
&M2	: Synchronous mode 2 (Dial Stored Number mode)
&P1	: Pulse dial make/break ratio = 33/67 (UK/HK)
&R	: CTS follows RTS
&R1	: Modem ignores RTS; CTS always ON
&T	: Terminate test in progress
&T1	: Initiate Local Analog Loopback test
&T3	: Initiate digital loopback
&T4	: Modem grants request from remote modem for RDL
&T5	: Modem denies request from remote modem for RDL
&T6	: Remote Digital Loopback test
&T7	: Initiate Remote Digital Loopback with self test
&T8	: Initiate Local Digital Loopback with self test

---



## Register Access Code

Register	Description
S0	: Number of rings before auto-answering a call. If set to 0, the modem will not auto-answer.
S1	: Counts incoming rings. If no ring occurs for 8 seconds, the counter is cleared to 0. The register only counts when the modem is set to auto-answer (S0 greater than 0).
S2	: Escape code character. Can be ASCII 0-127. Default is +. If S2 is greater than 127 then the escape code is completely disabled and only a call disconnection will return the modem to the command mode.
S3	: End-of-line character. This character is used to both terminate commands and to terminate status messages. Defaults to carriage return. (ASCII 13)
S4	: Line feed character. This character is output following the end-of-line after English status messages. Defaults to line feed (ASCII 10).
S5	: Backspace character. This character is typed to erase one command character and move the cursor back one space on the host screen. To erase a character, the modem first outputs a backspace, then it outputs a space and then another backspace to move over the blank. Default is backspace (ASCII 8).
S6	: Dial tone wait. Defines the pause after going off-hook (in seconds). Can't be less than 2 due to FCC regulations. Default is 2.
S7	: Time in seconds, to wait for carrier before aborting a connection attempt. Default is 30 seconds.
S8	: Length of pause, in seconds, produced by the comma command. Default is 2 seconds.
S9	: Time, in 1/10 seconds, that carrier must be present to be detected. Default is 600 milliseconds.
S10	: Time, in 1/10 seconds, between loss of carrier and disconnect. Default is 700 milliseconds. If S10 is set to 255, then the modem acts as if a carrier is always present.
S12	: Time Delay, in 1/50 seconds, required before and after an escape code. The time between the characters of the escape code must be less than the value of S12. If S12 is 0, then timing is not a factor in recognizing the escape code. Default is 1 second.

*Continued on next page*

## Register Access Codes, Continued

Register	Description
S16	: Test mode. S16, BIT 0: Local Analog Loop - 0-Disable, 1-Enable S16, BIT 1: Not Used S16, BIT 2: Local Digital Loopback - 0-Disable, 1-Enable S16, BIT 3: Remote Digital Loopback initiated by remote modem 0- Loopback off, 1-Loopback in progress S16, BIT 4: Remote Digital Loopback - 0-Disabled, 1-Initiate Enabled S16, BIT 5: Remote Delay Loopback with test message and error count 0-Disable, 1-Enable S16, BIT 6: Local Analog Loopback - 0-Disable, 1-Enable S16, BIT 7: Not Used
S25	: Delay to DTR. Transitions on DTR that occur for less time specified by this register are ignored. DTR will only be examined after S25 has timed out.
S26	: RTS to CTS Delay Interval used in synchronous operation. Upon detection of a transition and RTS the CH1780 will wait the duration specified by this register before returning a CTS.

**Note** All other Registers not indicated are not used.

**Dial descriptors** In addition to specifying a number to dial, the following descriptors can be used with the D Command

0-9 # * A B C D	Digits and characters for dialing
@	Wait for quiet answer (no dial tone transmitted)
!	Hookflash
;	Return to command state after dialing
,	Delay processing of next character
P	Pulse dial
R	Reverse mode (for calling an originate-only modem)
S=n	Dial number stored in location "n" (0-7)
T	Tone dial
W	Wait for dial tone

# Glossary

---

<b>Accumulated energy</b>	Total energy consumed since beginning of billing month.
<b>Ampere</b>	A unit of electrical current or rate of flow of electrons. One volt across one ohm of resistance causes a current flow of one ampere. A flow of one coulomb per second equals one ampere.
<b>Apparent power</b>	The product of voltage and current in a circuit in which the two reach their peaks at different times, or, in other words, there is a phase angle between voltage and current. Units are VA or some multiple thereof.
<b>Balanced load</b>	An alternating current power system consisting of more than two current-carrying conductors in which these current-carrying conductors all carry the same current.
<b>Billing date</b>	The first date in the billing monthly.
<b>Billing demand</b>	The demand level which a utility uses to calculate the demand charges on the current month's bill. If the rate schedule includes a ratchet clause or minimum demand charge, billing demand may or may not be the actual peak average demand for the current month.
<b>Capacitor</b>	A device consisting essentially of two conducting surfaces separated by an insulating material or dielectric such as air, paper, mica, plastic film, or oil. A capacitor stores electrical energy, blocks the flow of direct current, and permits the flow of alternating current to a degree dependent upon the capacitance and frequency.
<b>Connected load</b>	The total load which a customer can impose on the electrical system if everything was connected at one time. Connected load can be measured in horse-power, watts, or volt-amperes. Some rate schedules establish a minimum demand charge by imposing a fee per unit of connected load.
<b>Clamp-on CT</b>	A current transformer which clamps around a current-carrying conductor so that the conductor does not have to be opened for insertion of the transformer primary. Particularly suited for making energy surveys where current must be sensed at many points for relatively short periods.
<b>Current transformer (CT)</b>	An instrument transformer, intended for measuring or control purposes, designed to have its primary winding connected in series with a conductor carrying the current to be measured or controlled. Also see clamp-on CT, where the conductor itself acts as the primary. CT's step down high currents to lower values which can be used by measuring instruments. They must be used with caution.

<b>Current transformer ratio</b>	The ratio of primary amperes divided by secondary amperes.
<b>Day (Daily)</b>	Begins at 00:00:00 and ends at 23:59:59.
<b>Demand</b>	A measure of the customer load connected to the electrical power system at any given time. Units are usually watts, volt-amperes, or volt-ampere-reactive.
<b>Demand charge</b>	The charge which utilities apply to the billing demand for the current month. Units are usually dollars per kilowatt or dollars per volt or kilo-volt-ampere.
<b>Demand-hours</b>	The equivalent number of hours in a month during which the peak average demand is fully utilized. In other words, if energy consumption for the current month is X KWH and the peak average demand is Y kw, then the demand hours is equal to X/Y hours. The higher the number of demand hours the better the demand leveling situation and the more efficiently demand is being used. Many rate schedules have demand-hour-based energy breaks with the higher the demand-hour figure the lower the energy consumption rate in dollars per KWH.
<b>Demand interval</b>	Demand charges are based on peak average demand over a utility-specified time interval, not on the instantaneous demand (or connected load) at any given moment. Typical demand intervals are 15, 20, and 30 minutes, although under certain circumstances they can drop to as low as 5 minutes.
<b>Demand-utilization efficiency</b>	Related to demand-hours and really a measure of how successful demand leveling procedures have been. Calculated by dividing demand hours by 720, the number of hours in a 30-day billing period. Although demand-utilization efficiency depends heavily on the type of facility, in general an efficiency of 50 percent is considered average, 40 percent and lower poor, and 60 percent and higher good.
<b>Discretionary loads</b>	Loads which exhibit a “flywheel” effect so that removing them from the line for short periods of time does not affect business or plant operation or personal comfort. Typical are HVAC systems, hot water heaters, and snow-melt systems. These types of load provide the shed/restore capability required in power demand controller systems.
<b>Efficiency</b>	In general, the ratio of output power to input power expressed as a percentage. For electromechanical equipment such as motors it is very difficult to determine true efficiency under plant-floor conditions. Electric input power can be easily measured, but accurately determining mechanical output power is difficult.
<b>Energy consumption charges</b>	The charges a utility imposes for the consumption of real power in watts. Units are usually dollars per kilowatt-hour.

<b>Event</b>	A type of report that is stored in memory when either a Hi/Lo Limits trigger or an external trigger generates a report. Events can be viewed through the VIEW REPORTS option from the MAIN MENU, or they can be sent to one of the other output devices (printer or communication ports) when a certain trigger condition is met.
<b>Event memory</b>	Stores events (which are created when an Hi/Lo Limits trigger or external trigger generate a report).
<b>Fuel-adjustment charges</b>	The charges a utility imposes for changes in the cost of the fuel they use and other utility-cost factors. Frequently these charges are based on complex formulas which include many variables related to the cost of delivering electrical energy. Units are usually dollars per KWH.
<b>Frequency</b>	The number of recurrences of a periodic phenomenon in a unit of time. In electrical terms, frequency is specified as so many Hertz (Hz) where one Hz equals one cycle per second.
<b>Historical memory</b>	Stores data that is automatically saved at the end of each demand interval.
<b>Impedance</b>	The total opposition (i.e., resistance and reactance) a circuit offers to the flow of alternating current at a given frequency. It is measured in ohms.
<b>Induction motor</b>	An alternating current motor in which the primary winding (usually the stator) is connected to the power source and induces a current into a polyphase secondary (usually the rotor). Induction motors are the principal source of poor power factor problems.
<b>Inductor</b>	Also called an inductance or retardation coil. A conductor, wound into a spiral or coil to increase its inductive intensity, is used for introducing inductance into a circuit. An inductor retards the change of current flow through it.
<b>Initiator pulses</b>	Electrical impulses generated by pulse-initiator mechanisms installed in utility revenue meters. Each pulse indicates the consumption of a specific number of watts. These pulses can be used to measure energy consumption and demand.
<b>Installed load</b>	Equivalent to connected load.
<b>Kilowatt-hour (KWH)</b>	A unit of electrical measurement indicating the expenditure of 1,000 watts for one hour. Higher quantities are expressed in megawatt-hours, or the expenditure of one-million watts for one hour.
<b>Lagging current</b>	The current flowing in a circuit which is mostly inductive. If a circuit contains only inductance the current lags the applied voltage by 90°. Lagging current means lagging power factor of less than unity.

<b>Leading current</b>	The current flowing in a circuit which is mostly capacitive. If a circuit contains only capacitance the current leads the applied voltage by 90°. Leading current means leading power factor of less than unity.
<b>Load</b>	Any device or circuit which consumes power in an electrical system.
<b>Load factor</b>	A quantity related to connected load, installed load, and contracted load capacity. Utilities use load factor to establish a minimum billing demand.
<b>Load restoring</b>	The energization of loads that were previously removed from the line to limit load and control demand level.
<b>Load shedding</b>	The removal of loads from the line to limit load and control demand level.
<b>Month (Monthly), (Billing Month or Cycle)</b>	If Billing Dates are programmed: Begins at 00:00:00 of first date in billing month ends at 23:59:59 of last date in billing month. If Billing Dates are NOT programmed: Begins at 00:00:00 of date memory is cleared. Subsequent billing months begin on the same date every calendar month.
<b>Neutral</b>	The conductor used as the return path for the current from the load to the source in power measurement procedures. The neutral is frequently, but not necessarily, grounded.
<b>Ohm</b>	The unit of electrical resistance. One ohm is the value of resistance through which a potential difference of one volt will maintain a current flow of one ampere.
<b>Ohm's Law</b>	The voltage across an element of direct current circuit is equal to the current in amperes through the element multiplied by the resistance of the element in ohms.
<b>Overflow</b>	Type of memory that stops collecting data once the memory is full. Must be cleared to begin data collection again.
<b>Parameter</b>	Refers to different types of characteristic elements. In general, parameter is used to refer to the various units or value types that can be measured by the Power Platform (such as Volts, Amps, frequency, etc.).  The term parameter is also used to refer to the different programmable characteristics of the unit (such as time and date, site I.D., billing dates, etc.)
<b>Peak average demand</b>	The highest average load over a utility specified time interval during a billing period. If there is no ratchet clause in the rate schedule then the peak average demand is also the billing demand.
<b>Polyphase</b>	Having or utilizing several phases. A polyphase alternating current power circuit has several phases of alternating current with a fixed phase angle between phases.

<b>Potential transformer (PT)</b>	An instrument transformer, the primary winding of which is connected in parallel with the circuit whose voltage is to be measured or controlled. PT's are normally used to step down high voltage potentials to lower levels acceptable to measuring instruments.
<b>Potential transformer ratio</b>	The ratio of primary voltage divided by secondary voltage.
<b>Power factor</b>	The ratio of real power in watts of an alternating current circuit to the apparent power in volt-amperes. Also the cosine of the phase angle between the voltage applied to a load and the current passing through it.
<b>Power factor correction</b>	Steps taken to raise the power factor by bringing the current more nearly in phase with the applied voltage. Most frequently this consists of adding capacitance to increase the lagging power factor of inductive circuits.
<b>Power factor penalty</b>	The charge utilities impose for operating at power factors below some rate-schedule-specified level. This level ranges from a lagging power factor of 0.80 to unity. There are innumerable different ways by which utilities calculate power factor penalties.
<b>Present demand</b>	Instantaneous demand updated every second.
<b>Projected demand</b>	Average demand for the elapsed time of the demand interval.
<b>Pulse initiator</b>	A device added to a revenue meter which generates pulses proportional to meter disk rotation. Each pulse represents a discrete quantity of energy consumed. Frequently the pulses are generated photoelectrically and output through mercury-wetted relays.
<b>Q</b>	A phantom quantity used by power companies to calculate volt-ampere-reactive (var) when there are both leading and lagging power factors. A Q-hour meter will determine varhr's when the power factors vary from 30° leading to 90° lagging. A Q-hour meter is similar to a watt-hour meter except that the voltage applied to each potential coil lags by 60° the voltage supplied to the respective watt-hour meter potential coil. This can generally be accomplished by cross-phasing, thus eliminating the need for a phase-shifting transformer. The varhr information can be calculated as follows: $\text{varhr} = (2Q \text{ hr -w hr}) / (3^{1/2})$

<b>Ratchet clause</b>	A rate schedule clause which states that billing demand may be based on current month peak average demand or on historical peak average demand, depending on relative magnitude. Usually the historical period is the past eleven months although it can be for the life of the contract. Billing demand is either the current month peak average demand or some percentage (75 percent is typical) of the highest historical peak average demand, depending on which is largest.
<b>Reactance</b>	The opposition to the flow of alternating current. Capacitive reactance is the opposition offered by capacitors and inductive reactance is the opposition offered by an inductive load. Both reactances are measured in ohms.
<b>Reactive power</b>	Also called wattless power and measured in volt-ampere-reactive. Reactive power increases with decreasing power factor and is the component of apparent power which does no real work in a system.
<b>Real Power</b>	The component of apparent power that represents true work in an alternating current circuit. It is expressed in watts and is equal to the apparent power times the power factor.
<b>Report</b>	A unit of information pertaining to one or more channels and parameters. Through the monitoring setups, a report can be programmed to be sent to the memory card, printer, to one of the communication ports, or to the report memory, when a certain trigger condition is met. Present values for all available report types, and any reports stored in memory, can be viewed through MAIN MENU option 2, VIEW REPORTS.
<b>Report Memory</b>	Stores reports that have been programmed in the monitoring setup to be saved in memory.
<b>Resistance</b>	The property of a substance which impedes current flow and results in the dissipation of power in the form of heat. The unit of resistance is the ohm. One ohm is the resistance through which a difference of potential of one volt will produce a current of one ampere.
<b>Revenue meter</b>	A meter used by a utility to generate billing information. Many types of meters fall in this category depending on the rate structure.
<b>Root mean square (RMS)</b>	The effective value of alternating current or voltage. The RMS values of voltage and current can be used for the accurate computation of power in watts. The RMS value is the same value as if continuous direct current were applied to a pure resistance.
<b>Setup</b>	Consists of a number, title, and up to 32 reports. The types of reports programmed, and the conditions that must exist for the report to be generated, are all contained in a setup. A total of 32 setups can be programmed, although only one setup can be active at a given time.



<b>Single-phase</b>	An alternating current circuit in which only one phase of current is available in a two-conductor or three-conductor system where the load lines are 0° or 180° out of phase.
<b>Sliding demand interval</b>	A method of calculating average demand by averaging the average demand over several overlapping intervals. The intervals begin a short time span (step) apart, usually about five minutes. Updating average demand at short time intervals gives the utility a much better measure of true demand and makes it difficult for the customer to obscure high short-term loads.
<b>Time-dependent clauses</b>	Rate schedule provisions which vary rates depending on the time of day or time of year when energy is consumed. Frequently these clauses cover both demand and energy charges. There is money to be saved by operating high loads and consuming high amounts of energy during off-peak periods when rates are lower.
<b>Telephone Influence Factor</b>	Telephone Influence Factor (TIF) is a dimensionless quantity which describes the potential for interference by a power circuit on a communications circuit. TIF weighting factors take into account the relative interfering effects of various frequencies in the voice band. Weighting factors are calculated under the assumption that coupling between the power and communications circuits is directly proportional to the frequency. There is no accounting for the physical orientation of the two systems.
<b>Time-of-use period</b>	Utility company charge rates at different times and/or dates. For example, they may charge lower rates on weekends or holidays. On weekdays, they might charge one rate between 8 am and 5 pm, another rate between 5 pm and 10 pm, and still another rate between 10 pm and 8 am.
<b>Transformer Derating Factor (TDF)</b>	Excessive harmonics can cause premature failure of distribution transformers. This results from high winding “hot spot” temperatures caused by power dissipation due to the presence of harmonic currents in the windings. To maintain operation of a transformer in the presence of harmonic content, a derating factor should be used. TDF is the suggested value to be used.
<b>Trigger</b>	A condition that causes a report to be generated. For example, reports can be programmed to be generated at certain times of the day, when a measured parameter exceeds a certain limit, or when an external impulse is received at the digital inputs.
<b>True power</b>	Same as real power.
<b>Unbalanced loads</b>	A situation existing in an alternating current system using more than two current-carrying conductors where the current is not equal in the current-carrying conductors due to uneven loading of the phases.
<b>Volt-ampere (VA)</b>	The unit of apparent power. It equals volts times amperes regardless of power factor.

<b>Volt-ampere demand</b>	Where peak average demand is measured in volt-amperes rather than watts. In this case the customer is automatically penalized for operating at any power factor less than unity.
<b>Volt-ampere-reactive (var)</b>	The unit of reactive power, as opposed to real power in watts. One var is equal to one reactive volt-ampere.
<b>Volt-ampere-reactive demand</b>	Measuring var demand is a method of penalizing for poor power factor. Multiplying total peak average var demand by some rate (dollars per var) penalizes for operating at any power factor less than unity. Frequently there is a quantity of “free” var which is determined as some percentage of the peak average watt demand. All excess var over this quantity is then billed at this dollars per var rate. Effectively this penalizes for operating below some specified power factor less than unity.
<b>Volt-ampere-reactive-hour</b>	The measure of the number of var's used in one hour. Var-hr and w-hr are frequently used to calculate average power factor during a billing period.
<b>Voltage (v)</b>	The force which causes current to flow through a conductor. One volt equals the force required to produce a current flow of one ampere through a resistance of one ohm.
<b>Watt (w)</b>	A measure of real power. The unit of electric power required to do work at the rate of one joule per second. It is the power expended when one ampere of direct current flows through a resistance of one ohm.
<b>Watt demand</b>	The usual demand billing factor where peak average demand is measured in watts or real power.
<b>Watt-hour (wh)</b>	A unit of electrical work indicating the expenditure of one watt of electrical power for one hour.
<b>Wattmeter</b>	An instrument of measuring the real power in an electric circuit. Its scale is usually graduated in watts, kilowatts, or megawatts.
<b>Week (Weekly)</b>	Begins at 00:00:00 on Sunday, ends at 23:59:59 on Saturday.
<b>Wrap</b>	Type of memory that continues to collect data when full by writing over the earlier (oldest) data it has collected. This process continues with data constantly writing over older data.

# Index

## A

- AC Power Source 3-5
- Alarm
  - turning on and off 4-7
- All Channels, One Parameter Screen 3-51
- Alphabetic Entry Screen 4-2
- Analyzer Status Screen 4-9
- Apparent Power
  - formula F-8

## B

- Battery Pack
  - replacement C-5
  - replacing fuse D-5
  - specifications C-2
  - status of H-4
- Battery, Lithium C-2

## C

- Calibration 1-9
- Channel Selection Screen 3-48
- Circuit Type
  - selecting 5-4
- Configure I/O Menu Screen 9-5
- Current
  - ABC totals formula F-7
- Current Channels
  - specifications F-5
- Current Connections
  - current probe 3-21
  - current probe example 3-25
  - current transformer (CT) 3-26, 3-27
  - guidelines 3-24
  - isolated current transformers 3-28, 3-29
  - safety precautions 3-12, 3-21
- Current Phasors
  - viewing 3-52
- Current Probes
  - connecting 3-21

- connection example 3-25
- description A-4
- specifications F-9
- types of 3-22

- Current Transformers
  - connecting 3-26, 3-27
  - safety precautions 3-26
  - types of 3-27

## D

- Data Card, see Memory Card
- Data Channel Selection Screen 7-10
- Date
  - setting 4-4
- DC Connector Plug
  - description H-3
- DC Power Source, External
  - making cable for H-3
- Delta
  - floating, connection diagram 3-39
  - floating, phasor diagram 3-44
  - high-leg, connection diagram 3-42
  - high-leg, phasor diagram 3-44
  - one leg grounded, connection diagram 3-40
  - one leg grounded, phasor diagram 3-43
  - open leg, connection diagram 3-41
  - open leg, phasor diagram 3-44
  - red-legged, connection diagram 3-42
- Digital Inputs
  - description 1-8
  - snapshot enable connection diagram 6-13
  - start/stop 6-12
  - start/stop connection diagram 6-13
  - terminal block 6-12
- Display, see LCD

## E

- Enter Site/File Name Screen 4-2
- Envelope Mode Plot
  - viewing 7-2
- Envelope Mode Screen 7-2
- Envelope Parameter Formulas 7-13
- Envelope Parameter Selection Screen 7-12

Error Messages  
  descriptions G-3  
  priority G-2  
  TASKCard 3-8, 3-9  
External Battery Charger A-5  
External Battery Filter  
  description H-6  
  extension cables H-7  
  installation H-8  
External Disk Drives A-5

## F

Fax  
  specifications F-3, F-4  
Frequency Synchronization  
  definition 5-9  
  entering internal frequency 5-11  
  loss of 5-10  
  when collecting inrush data 6-1  
Fuses  
  replacing battery D-5  
  replacing main power D-2  
  types of D-1

## H

Handbook for Energy Management A-5  
Harmonics  
  viewing in meter mode 3-53

## I

Input Channel Configuration Screen 5-2  
Input Channels  
  definition 5-2  
  turning on and off 5-2  
Inrush Data  
  channel selection 7-10  
  envelope parameter formulas 7-13  
  envelope parameters 7-12  
  reading from memory card 8-5  
  viewing data mode 7-14  
  viewing modes 7-1

  writing to memory card 8-2  
Internal Modem  
  description A-4  
ISO Boxes, see isolated current transformers  
Isolated Current Transformers  
  applications 3-29  
  connecting 3-28, 3-29  
  connecting to non-Dranetz-BMI current  
    probe 3-32  
  connecting to permanently installed CT 3-30  
  description A-4  
  in-line connection 3-31  
  safety precautions 3-28  
  specifications F-10

## L

Language  
  selecting 4-6  
LCD  
  backlight auto-shutoff 4-7  
  invert mode 4-7  
  normal mode 4-7

## M

Measurement Cable Set 3-15  
Memory Card  
  description 1-8, A-4  
  formatting 8-6  
  reading from 8-5  
  writing to 8-2  
Memory Card Functions Screen 8-1  
Memory Card Readers A-5  
Messages  
  descriptions G-3  
  priority G-2  
Meter Mode  
  available parameters 3-49  
  description 1-6  
  viewing 3-49  
  viewing harmonics 3-53  
Meter Mode Menu Screen 3-50  
Modem  
  internal, specifications F-3, F-4

## O

One Channel, All Parameters Screen 3-50

Optional Accessories

current probes A-4

extension cables for external battery filter  
H-7

external battery charger A-5

external battery filter H-6

external disk drives A-5

Handbook for Energy Management A-5

internal modem A-4

isolated current transformers A-4

list A-2

memory card A-4

memory card readers A-5

RS232 cables A-4

TASKCard 8000 A-4

Other Devices Configuration Screen 4-7, 9-4

## P

Phasor Diagrams

for standard power connections 3-43

viewing 3-52

Potential Transformers

connecting 3-19

definition 3-19

scale factor 3-20

Power Factor

formula F-8

Power Measurements

delta, one leg grounded 3-40

floating delta 3-39

four wire wye 3-38

high-leg delta 3-42

open leg delta 3-41

phasor diagrams 3-43

single phase 3-36

split phase 3-37, 3-38

Power Platform

connecting to an AC power source 3-5

front panel 2-2

installing TASKCard 3-6

operating on internal battery 3-5

operational description 1-6

physical description 1-4

positioning 2-8

rear panel 2-4

setting the voltage selector 3-3, 3-4

standard accessories 1-4

turning on 3-7

Pre-trigger

definition 6-3

setting 6-6

Pre-trigger Bar 7-8

Printer

internal, assembly 9-2

internal, controls 9-3

internal, normal operation 9-5

internal, paper replacement 9-7

internal, turning on and off 9-4

specifications F-3

## R

Ratio Bar 7-7

Reactive Power

formula F-8

Read Data From Memory Card Screen 8-5

Read Memory Card 8-5

Recording Duration

definition 6-4

maximum per channel 6-5

setting 6-7

Relays

specifications F-4

Repacking for Return Shipment B-1

Replaceable Parts List E-1

RS232

optional cables A-4

port specifications F-3

Run Self-Test Screen 4-9

## S

Samples Per Cycle

settings 6-4

Scale Factors

definition 5-6

- entering 5-7
- examples 5-6
- for Dranetz-BMI equipment 5-6
- range 5-7
- when to use 5-6
- Scope Mode
  - description 1-7, 3-47
  - selecting channels for display 3-48
  - viewing 3-47
- Scope Mode Plot
  - screen 7-4
  - viewing 7-4
- Scope Mode Screen 3-8, 3-10
- Self-Test
  - running 4-8
- Set Inrush Trigger Type Screen 6-3
- Set Scales Screen 3-54
- Set Time and Date Screen 4-4
- Setups
  - reading from memory card 8-5
  - writing to memory card 8-2
- Single Phase
  - connection diagram 3-36
  - phasor diagram 3-43
- Site Name
  - entering 4-2
- Site Status Screen 4-8
- Snapshot Enable
  - connection diagram 6-13
- Spare Parts E-1
- Specifications
  - computed parameters F-7
  - current probes F-9
  - general F-2
  - interfaces F-3
  - isolated current transformers F-10
  - measured parameters F-5
- Split Phase
  - connection diagram 3-37, 3-38
  - phasor diagram 3-43
- Standard Accessories 1-4
  - DC connector plug H-3
  - measurement cable set 3-15
  - terminal blocks 6-12
- Start/Stop
  - connection diagram 6-13

- definition 6-12

## T

- TASKCard
  - 8000 A-4
  - error messages 3-8, 3-9
  - inrush 1-1
  - installation 3-6
- Terminal Block
  - for digital inputs (six-position) 6-12
  - wire gauges 6-13
- Time
  - setting 4-4
- Trigger
  - setting manual 6-8
  - setting rms 6-9
- Turn On Procedure 3-7

## V

- Voltage
  - ABC totals formula F-7
- Voltage & Current Phasors Screen 3-52
- Voltage and Current Harmonics Graph Screen
  - 3-53
- Voltage and Current Harmonics Text Screen 3-55
- Voltage Channels
  - specifications F-5
- Voltage Connections
  - neutral to ground example 3-18
  - potential transformers 3-19
  - safety precautions 3-12
  - single phase example 3-17
  - voltage probe 3-17
- Voltage Phasors
  - viewing 3-52
- Volt-Amps
  - formula F-8
- Volt-Amps Reactive
  - formula F-8

## **W**

Watts

    formula F-7

Wiring Configuration and Scale Factors Screen

    5-4, 5-7, 5-11, 5-12

Write Data to Memory Card Screen 8-2

Wye

    four wire, connection diagram 3-38

## **Z**

Zoom Screen 7-5